

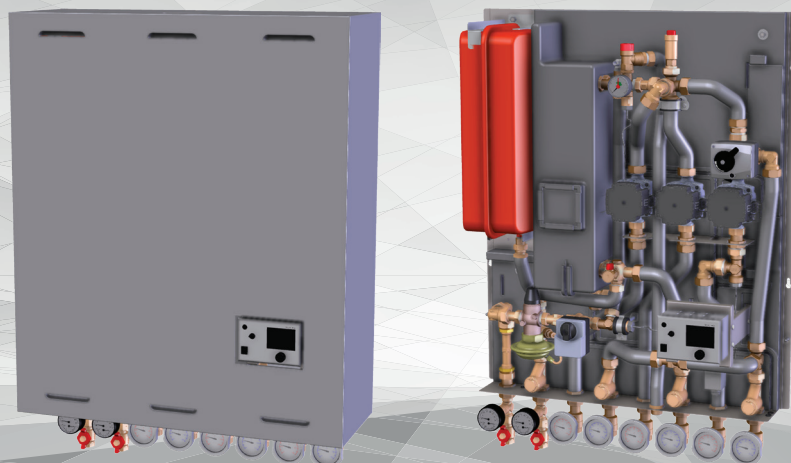

Logotherm

LogoMini G2

Indirect, wall-mounted, thermally insulated, compact local and heat interface units
S-Line, up to 20 kW



ENG Installation and servicing instructions

Table of contents

List of abbreviations.....	4
1. Safety instructions	5
1.1 Intended use	6
1.1.1 Use for intended purpose	6
1.1.2 Improper use	7
1.2 Device designation	7
1.3 Hazard notes	7
1.4 What to do in the event of breakdown or leaks	8
1.5 Spare parts	9
1.6 Requirements on trained engineers	9
1.7 Liability and copyrights	9
1.8 Earth bonding or protective earthing in accordance with VDE.....	9
2. Description and technical data	10
2.1 Features	10
2.2 Product designations.....	11
2.3 Summary of the standardised station variants	11
2.4 Technical data of the heat interface unit.....	12
3. Design and components	13
3.1 Housing and thermal insulation	13
3.2 Description of the variants.....	14
3.2.1 Heat interface unit variant 1 (M10830.010)	14
3.2.1.1 Components.....	14
3.2.1.2 Dimensions.....	14
3.2.1.3 Hydraulic diagram.....	15
3.2.1.4 Wiring diagram.....	15
3.2.2 Heat interface unit variant 2 (M10830.210)	16
3.2.2.1 Components.....	16
3.2.2.2 Dimensions.....	16
3.2.2.3 Hydraulic diagram.....	17
3.2.2.4 Wiring diagram.....	17
3.2.3 Heat interface unit variant 3 (M10830.220)	18
3.2.3.1 Components.....	18
3.2.3.2 Dimensions.....	18
3.2.3.3 Hydraulic diagram.....	19
3.2.3.4 Wiring diagram.....	19
3.2.4 Heat interface unit variant 4 (M10830.510)	20
3.2.4.1 Components.....	20
3.2.4.2 Dimensions.....	20
3.2.4.3 Hydraulic diagram.....	21
3.2.4.4 Wiring diagram.....	21
3.2.5 Heat interface unit variant 5 (M10830.520)	22
3.2.5.1 Components.....	22
3.2.5.2 Dimensions.....	22
3.2.5.3 Hydraulic diagram.....	23
3.2.5.4 Wiring diagram.....	23

3.2.6	Heat interface unit variant 6 (M10830.530)	24
3.2.6.1	Components.....	24
3.2.6.2	Dimensions.....	24
3.2.6.3	Hydraulic diagram.....	25
3.2.6.4	Wiring diagram.....	25
3.2.7	Heat interface unit variant 7 (M10930.010)	26
3.2.7.1	Components.....	26
3.2.7.2	Dimensions.....	26
3.2.7.3	Hydraulic diagram.....	27
3.2.7.4	Wiring diagram.....	27
3.3	Legend	28
4.	Installation	30
4.1	Installation instructions for mounting, connecting and cable routing options.....	30
4.2	Installation instructions.....	31
5.	Individual components	33
5.1	Electronic system controller	33
5.2	Primary components	34
5.2.1	Relay valves and controllers	34
5.2.2	Shut-off, thermometer and manometer and components	36
5.3	Secondary components	37
5.3.1	Space heating circuit / tank charging pump	37
5.3.2	Shut-off valves.....	38
5.3.3	Other components	39
5.4	Filter/strainer in primary/secondary circuit.....	40
5.5	Accessories	41
5.6	Installation of optional heat meters in the primary heating circuit.....	41
5.7	Spare parts	43
6	Commissioning	43
6.1	Flushing and filling	44
6.2	Initial start-up.....	44
6.3	Heating system	45
6.4	Domestic water heater.....	45
6.5	Adjusting the digital controller.....	46
6.6	Notes on thermostatically controlled station variant 7 (M10930.010).....	46
7	Maintenance and service	47
7.1	Information regarding domestic water hardness	48
7.2	Seized Grundfos pumps, type UPM3.....	48
8	Design diagrams	50
8.1	Summary.....	50
8.2	Primary flow rates and return line temperatures.....	51
8.3	Flow and pressure losses and available differential pressure.....	59
8.3.1	Diagrams for LogoMini G2 variants 1...6	59
8.3.2	Diagrams for LogoMini G2 variant 7	63
9	Decommissioning, dismantling, disposal, environmental protection and disposal of electrical and electronic equipment	66

List of abbreviations

Abbreviation	Definitions
FL	Flow line
RL	Return line
HFM	Energy meter
MT	Male thread
FT	Female thread
prim.	Primary side (from the heat generator)
sec.	Secondary side (to the heat consumer)
TCC	Technical Connection Conditions*
STM	Safety temperature monitor
DWH	Domestic water heater (tank charging/continuous flow principle)
CW	Domestic water
DHW	Domestic hot water
DWC	Domestic water circulation (DHWC)
UC	Unmixed heating circuit
MC	Mixed heating circuit
UHC	Underfloor heating circuit
AT	Outside temperature sensor
T	Tank
DHTCP	Domestic hot water tank charging, primary side
DHTCS	Domestic hot water tank charging, secondary side
BV	Ball valve
TH	Thermostatic head
BP	Backflow limiter
UN	Union nut
PHE	Plate heat exchanger
HC	Heating circuit
DPC	Differential pressure regulator, primary side

* Technical Connection Conditions are specified by the network operator for the technical and functional fitting out and operation of the station (specification of components may also be possible).

1. Safety instructions



Please follow the safety instructions below carefully to prevent hazards and injury to persons and property.

These operating instructions are primarily designed for the safe use and installation of the device and make no claims to completeness.

These operating instructions describe the functionality of the device and are intended to provide information about the required safety instructions and to draw attention to possible hazards. Further technical information can be found in the other applicable documents.

These operating instructions are valid only for the described device and are not subject to the manufacturer's revision service. The sketches and drawings they contain are examples only and not to scale.

- Keep the operating instructions within easy reach of all employees instructed to carry out work on the device so that they can refer to them as required.
- Keep the operating instructions in a clean, complete and legible condition throughout the entire period of use.
- Read the operating instructions before working on the device for the first time and consult them whenever uncertainties or doubts arise as to how the device should be handled.
- Should you come across any discrepancies when reading these operating instructions or should anything remain unclear, please contact the manufacturer.

Target group

These instructions are intended exclusively for authorised trained experts.

Only trained experts/installers authorised by the respective competence authority are permitted to work on heating systems, domestic water, gas and electrical circuits.

Regulations

When carrying out work, you must comply with:

- The legal regulations regarding accident prevention and environmental protection, the Employer's Liability regulations and the regulations (such as technical connection conditions) and specifications of the relevant energy utility company (EVU)
- The pertinent safety requirements of DIN, DIN, EN, DVGW, VDI, TRGI, TRF and VDE,
- ÖNORM, EN, ÖVGW-TR Gas, ÖVGW-TRF and ÖVE,
- SEV, SUVA, SVGW, SVTI, SWKI and VKF
- and all current region or country-specific regulations, technical rules and standards

Instructions for working on the system

- Disconnect the system from the mains and monitor it to ensure that no voltage is being supplied (e.g. at the separate cut-out or a main switch).
- Secure the system from restarting / switching to auxiliary power supply.
- WARNING! Risk of scalding at media temperatures: >60°C

Note: In the case of anticipated high primary temperatures of >60°C, thermostatic scalding protection must be ensured at the domestic hot water draw-off point in order to restrict the outlet temperature accordingly.

Permissible mains supply and operating parameters

- Heating side/primary side:	Permissible pressure rating: Max.	PN10
	permissible operating temperature:	110°C
- Heating side/secondary side:	Permissible pressure rating: Max.	PN3
	permissible operating temperature:	90°C (partially pump-dependent)
- Sanitary side*/secondary side:	Permissible pressure rating: Max.	PN6
	permissible operating temperature:	90 °C
	Min. cold water pressure:	2.0 bar
	Recommended CW working pressure:	2.5 bar

* Depending on heat interface unit variant: Use in the domestic water sector permissible (secondary side, separate PHE)

- Approved heating medium (cf. DIN EN 12828): heating water according to VDI 2035 (not corrosive), water/glycol mix with max. 30 % glycol proportion

Environmental and connection conditions:

- Permissible ambient temperature: 5...40°C (non-condensing), dry ambient conditions: Avoid installing the station in areas with high ambient humidity as there is a risk of electric shock and increased risk of corrosion.
- The station must be installed in enclosed, dry, frost-free spaces.
- Any noise emissions or radiant heat from the station must be taken into account in the choice of setup/installation site.
- Observe the safety areas in accordance with EN 60529 when designing and installing the system.
- The fire protection classes of any thermal insulation used must be observed.
- Any domestic hot water (DHW) installation must be made safe in compliance with DIN 1988 or DIN EN 806, for example, i.e. with the use of a safety valve and, where applicable, an expansion vessel.

1.1 Intended use

1.1.1 Use for intended purpose

Heat interface units are used for the contractual transmission of heat between the district heating provider's network and the domestic system. The heat interface unit may also control the space heating system and/or a domestic water heater.

Heat interface units may only be used for this purpose in compliance with the maintenance and operation instructions and all pertinent local standards and regulations.

Any additional or alternative use is not permitted and regarded as an unintended use. All instructions in the operating instructions must be followed and the maintenance schedule adhered to.

Any deviation from the intended use may cause unintended hazards and is fundamentally not permitted.

Appropriate use in heating and domestic water systems must be in accordance with the applicable DIN and local standards. Installing and operating the assembly incorrectly will invalidate any warranty claims. The shut-off valves may only be closed by an approved specialist when servicing, otherwise the safety valves will not work.

The heat interface unit is not suitable for installation in recreation rooms or bedrooms. Care must be taken to avoid sound transmission to adjacent walls or rooms!

**Caution:**

Do not make any changes to the electrical components, the design of the equipment or the hydraulic components! This would adversely impact on the safe function of the equipment.

Instructions concerning the place of use:

Before using our products, they must be checked regarding their suitability for the respective application. In particular for heating systems, please take into account the properties of the heating water in accordance with VDI 2035 to protect the heating system and, for domestic water applications, the water quality at the place of use. In the case of critical water qualities, please take action where necessary (e.g. water treatment) to prevent functional impairment and/or damage, e.g. corrosion damage. In particular, please check the permissible limit values, e.g. electrical conductivity, the pH value, the water hardness level and the ammonium concentration. Furthermore, in Germany all applicable norms, regulations and guidelines specific to the federal states must be taken into consideration, alongside the instructions in the applicable installation and operating manuals.

Further information can be found in the download section at www.flamcogroup.com.

1.1.2 Improper use

Using the device in any way that does not correspond to the intended use may be hazardous and is therefore prohibited.

In particular, the following is not allowed:

- The use of liquids other than water with the described properties
- Use of the device without prior knowledge of the operating instructions
- Use of the device without legible warning and information signs
- Use of the device in a faulty condition

1.2 Device designation

Designation:	LogoMini G2
Function:	Transfer of thermal energy to the space heating supply or for domestic hot water preparation
Type:	S-Line
Manufacturer:	Meibes System-Technik GmbH, Gerichshain

1.3 Hazard notes

The safety and warning information draws attention to residual hazards that cannot be avoided due to the design and construction of the device. Please always observe the measures shown for avoiding these hazards.

Never alter or modify the unit yourself. Such work may only be carried out by **trained, specialist personnel**. This also applies to the electrical installation.

When the system is in operation, water-regulating components will be hot. Touching these system components can lead to scalding. The heat interface units must be operated with thermal insulation. The thermal insulation is integrated into the units' housing. The housing insulation not only prevents unnecessary heat dissipation, but also protects against accidental contact and burns. For this reason, the housing with thermal insulation may only be removed for maintenance/repair purposes and must be properly replaced immediately after completion.

The system is operated using hot, high-pressure water, which can cause scalding on contact.

You should therefore open the bleed or drain valves carefully and not work on pressurised parts.

The control components (controller, servomotors, pumps, etc.) are powered by mains voltage.

Therefore, always ensure the station is disconnected from the mains electrical supply when carrying out any maintenance or repair work. Secure the system against unauthorised operation.

Life-threatening electric shocks can be caused by spraying or splashing water. Escaping water may also disable the safety devices.

Any changes made to the heat interface unit that have not been authorised by the manufacturer will invalidate any warranty claims.

Residual hazards:

The product has been built in accordance with the most relevant and recognised safety regulations. The following residual hazards may arise during installation, commissioning, maintenance and disassembly:

Warning: Risk of scalding from high media temperature

- Work with particular caution.
- Use personal protective equipment PPE (e.g. heat-resistant protective gloves).
- If necessary, the surface temperature must be measured before commencing any work.
- Use only designated and appropriate tools.

Hazard: Risk of injury from electrical voltage

- Only trained and qualified electricians may undertake work on electrical equipment.
- Electrical installation spaces must always be kept locked.

Warning: Risk of cuts and scratches due to the possibility of sharp edges

- Work with particular caution.
- Use personal protective equipment PPE (e.g. protective gloves).

Warning: there is a risk of impact/crushing if the unit falls over

- Wear personal protective equipment PPE (such as protective work shoes).

1.4 What to do in the event of breakdown or leaks

- Isolate the unit using the appropriate valves.
- Contact a suitably trained expert or the customer service department of the manufacturer.

The device will only be cleared for operation again when the trained engineer has remedied the fault and restored the device to its intended condition.

1.5 Spare parts

All spare parts to be used, must correspond to the technical requirements defined by Meibes System-Technik GmbH. This is guaranteed only by using genuine spare parts. The manufacturer is not liable for damage caused by the use of unapproved spare parts or ancillary materials. Appropriate spare parts can be found in our documentation.

1.6 Requirements on trained engineers

A qualified professional must have undergone advanced technical training and have sufficient experience to independently perform complicated tasks or work associated with residual hazards. Each experience refers to a certain speciality, e.g. Maintenance, Electrical and/or HVAC Technician. In preparation for impending work, a qualified professional must be able to correctly estimate the feasibility, risks and hazards of the work as well as the equipment required. A qualified professional is expected to understand complex plans and descriptions of minimum preparation, and to obtain missing and required detailed information by suitable means. The qualified professional must be able to restore and verify the intended/original state of the system.

A worker can be a trained expert in several fields.

For the performance of electrical works, only trained electricians according to DGUV regulation 3 may be used.

1.7 Liability and copyrights

We reserve all copyrights to this document. Any misuse, in particular reproduction or disclosure to third parties, is prohibited.

This original operating manual may not be reproduced or distributed, either in part or in its entirety, without the express permission of the manufacturer. This also applies to translations of this document and storage on other media. This document must not be used outside its intended purpose.

These installation and operating instructions must be given to the customer. The technician carrying out and/or authorising the work (e.g. installer) must explain the function and operation of the system to the customer in a comprehensible way.

1.8 Earth bonding or protective earthing in accordance with VDE

A terminal for earth bonding is provided on all heat interface units. An appropriately labelled earth stud can be found on the base plate for this purpose. Connection cross-section according to the applicable standards and regulations.

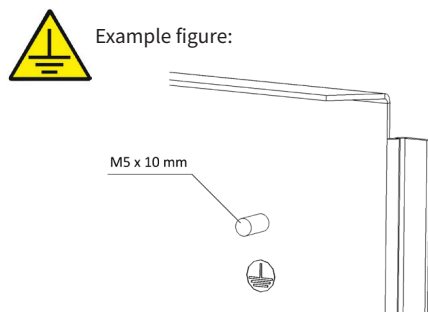

2. Description and technical data



The LogoMini G2 are compact heat interface units for the supply of district heating to indirect systems.

The models are wall-mounted with an EPP thermally insulated sheet metal housing. The primary and secondary connections are located at the bottom.

The units are pre-assembled and wired with a weather-compensating heating system controller.

Components and heat-insulated pipes are installed on the base plate, connected and checked.

The connections to the space heating circuit supply (mixed/unmixed) are made on the secondary side. The connection to the domestic hot water preparation (via an accumulator tank) is possible on the primary or secondary side* (with priority switching) or via the continuous flow principle*.

*Depending on station variant

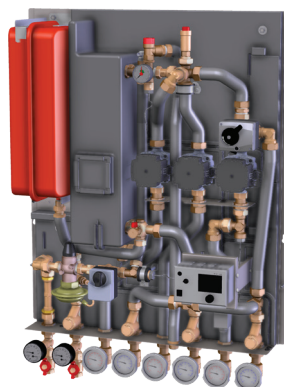

2.1 Features

- Compact heat interface unit in sheet metal housing incl. EPP thermal insulation
- with stainless steel plate heat exchanger (copper brazed)
- Primary supply and secondary circuit connections from underneath
- Strainer/filter accessory on connections (inlets to the unit, primary flow line, secondary return line)
- Safety group on the secondary side, including display gauge
- Vent line of the safety valve runs from the station downwards
- HFM adapter in the primary return line for heat flow meter 1" male thread x 130 mm (or with reduction pieces 3/4" male thread with 110 mm) and primary FL to the DWH* 3/4" male thread x 110 mm construction length
- Included on the secondary side is a 12-litre expansion vessel with refill valve
- Bleed points on the primary / secondary side
- Control valves in the primary circuit
- Space Heating pumps with backflow limiter in the secondary circuit
- Pre-set controller

* Depending on unit variant

2.2 Product designations

Key to product designations:

Example representation of a product code*

LogoMini G2	S-Line	I-HW	MC-UC	-DPC	-DHWC	-SA	
							Type of controller: SA: Samson
							DWC integrated: DHWC present
							Differential pressure regulator: DPC: Present on the primary side
							Type of heating circuit: MC: mixed UC: unmixed
							DWH: I-HW: indirect, via separate PHE DHTCP: Storage tank charging system, primary side DHTCS: Storage tank charging system, secondary side
							Performance class: S-Line

*Note: Some variant options will conflict with others and so a final combination will need to be verified by the manufacturer

LogoMini G2, S-Line, standardised variants:

Variants	Product designation	Art. No.	See section
1	LogoMini G2 S-Line UC DPC SA	M10830.010	3.2.1
2	LogoMini G2 S-Line STP UC DPC SA	M10830.210	3.2.2
3	LogoMini G2 S-Line STP UC SA	M10830.220	3.2.3
4	LogoMini G2 S-Line STS MC DPC SA	M10830.510	3.2.4
5	LogoMini G2 S-Line STS UC DPC SA	M10830.520	3.2.5
6	LogoMini G2 S-Line STS MC-UC DPC SA	M10830.530	3.2.6
7	LogoMini G2 S-Line I-HW UC DPC DHWC SA	M10930.010	3.2.7

2.3 Summary of the standardised station variants

LogoMini G2, S-Line with Samson controller as standard variants:

Variants	Domestic water heater (DWH)				Heating circuits		Primary circuit
	Primary connection for domestic hot water (DHW) accumulator tank	Secondary connection for domestic hot water (DHW) accumulator tank	Continuous flow principle via separate Plate Heat Exchanger (PHE)	Domestic water circulation present (DWC)	Unmixed UC	Mixed MC	Differential pressure regulator present
1	-	-	-	-	UC (UFH)	-	DPC
2	DHTCP	-	-	-	UC	-	DPC
3	DHTCP	-	-	-	UC (UFH)	-	-
4	-	DHTCS	-	-	-	MC (UFH)	DPC
5	-	DHTCS	-	-	UC	-	DPC
6	-	DHTCS	-	-	UC	MC (UFH)	DPC
7	-	-	I-HW	DHWC	UC (UFH)	-	DPC

2.4 Technical data of the heat interface unit

LogoMini G2, S-Line	Variants	1	2	3	4	5	6	7
Rated output** Heating / DWH		20 kW						10 kW / 45 kW
Max. dimensions (H x W x D)	Approx. 940 x 780 x 290 mm (without BV), H = approx. 1070 mm (with BV)							
Weight	Approx. 50 kg							
max. differential pressure	Primary	8 bar	***	8 bar			2 bar	
min. differential pressure		0.5 bar						
max. tightness	Primary	PN 10						
	Secondary, heating	PN 3						
	Secondary, sanitary*	-						PN 6
max. permissible operating temperature	Primary	110°C						90°C
	Secondary, heating	90 °C						
	Secondary, domestic hot water (DHW)*	-						90 °C
Design temperatures (FL/RL)	Primary	75 °C / 47 °C						75 °C / 30 °C
	Secondary	65°C / 45°C (radiator)						37 °C / 30 °C (UFH)
Design flow rates** (without 110°C)	Primary heating	approx. 650 l/h						approx. 150 l/h
	Primary sanitary*	-						approx. 700 l/h
	Secondary, heating	approx. 900 l/h						approx. 1200 l/h
	Secondary, domestic hot water (DHW)*	-						approx. 1020 l/h at ΔT 40K
Connection dimension	Primary	DN20, ¾" FT						
	Secondary	DN20, ¾" FT						
HFM adapter	RL primary and FL primary DHW*	Adapters for HFM installation: 1" male thread with 130 mm construction length, following removal of existing reducing pieces (not with HFM adapter for DWH*), otherwise ¾" male thread with 110 mm construction length						

* Depending on unit variant

** Power varies depending on the system parameters, see diagrams Section 8

*** Differential pressure regulator adapter depending on customer installation

3. Design and components

3.1 Housing and thermal insulation

Sheet metal cover and EPP thermal insulation

The units' housing comprises of several components. The front sheet metal covers with permanently integrated insulating plates (V1) and thermal insulation shells of the plate heat exchangers (V3) minimise heat losses and at the same time allow cooling of the unit's electronics.

The white (RAL 9016) sheet metal surface-mounted cover (V1) has dimensions (HxWxD) of 920 x 780 x 280 mm and is hung at the top on the station's base plate (U). The cover is also attached using quick-snap closures (W) to the base plate (U) on the side at the bottom.

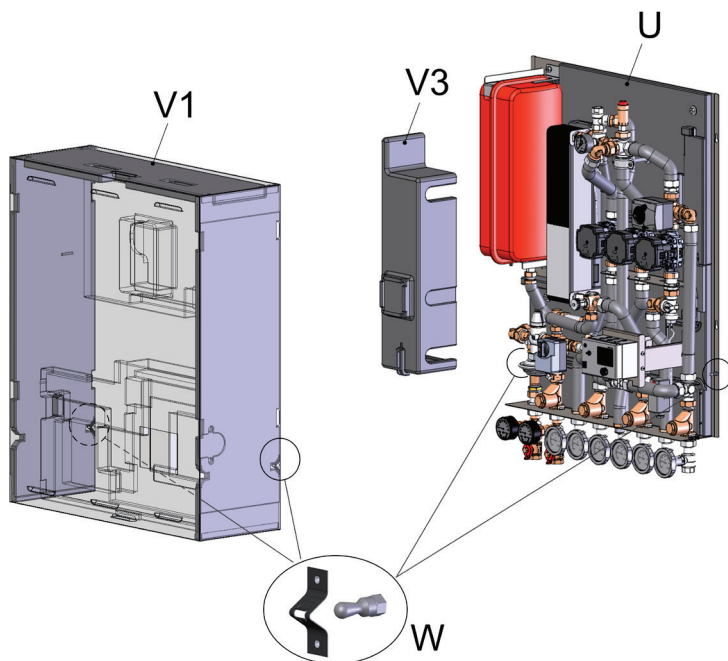

Note: The thermal insulation made of EPP has a B2 fire rating, meaning that it is not exceptionally flammable.

Legend:

Individual parts of the housing and thermal insulation

V1	Sheet metal surface-mounted cover with integrated thermal insulation plates
V3	Thermal insulation shell for plate heat exchanger
W	Rapid nipple with snap closure
U	Station base plate with rear thermal insulation plate

3.2 Description of the variants

3.2.1 Heat interface unit variant 1 (M10830.010)

3.2.1.1 Components

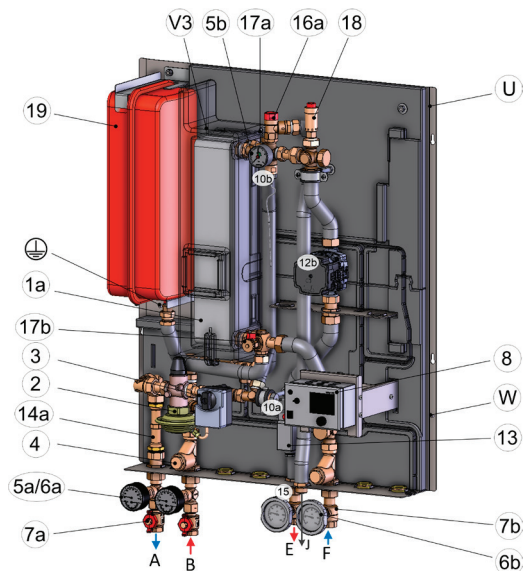

3.2.1.2 Dimensions

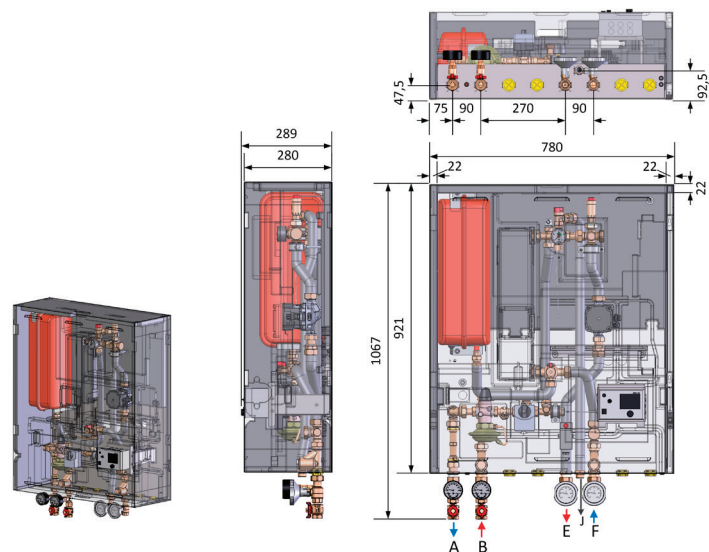

3.2.1.3 Hydraulic diagram

Heat interface unit variant 1 (M10830.010)

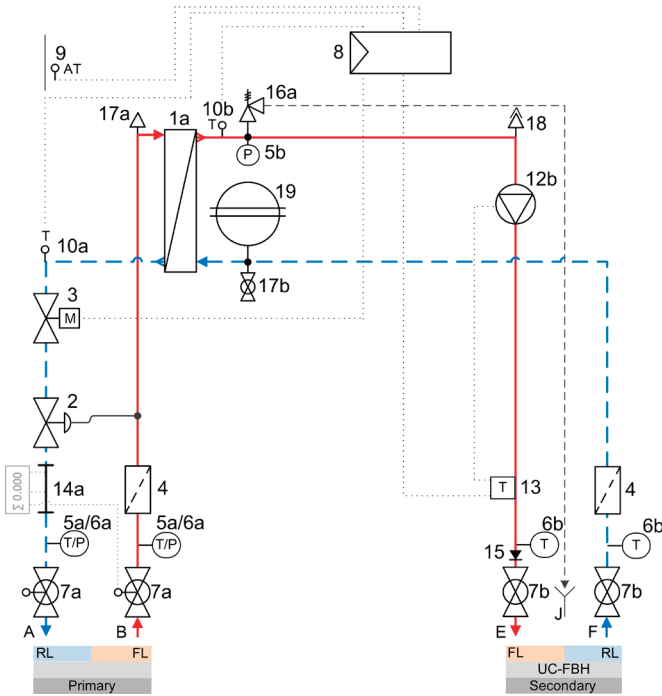

3.2.1.4 Wiring diagram

Heat interface unit variant 1 (M10830.010):

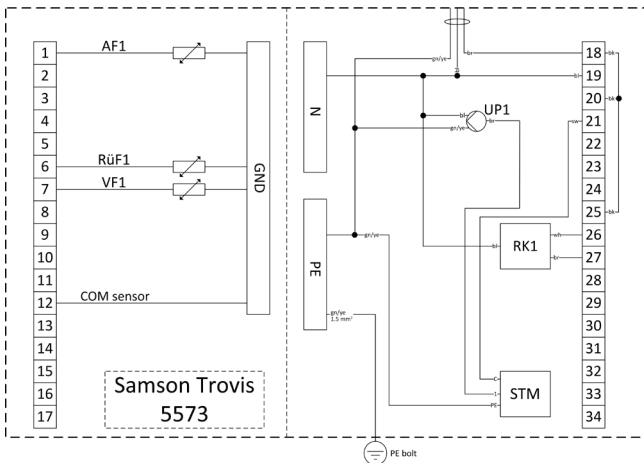

3.2.2 Heat interface unit variant 2 (M10830.210)

3.2.2.1 Components

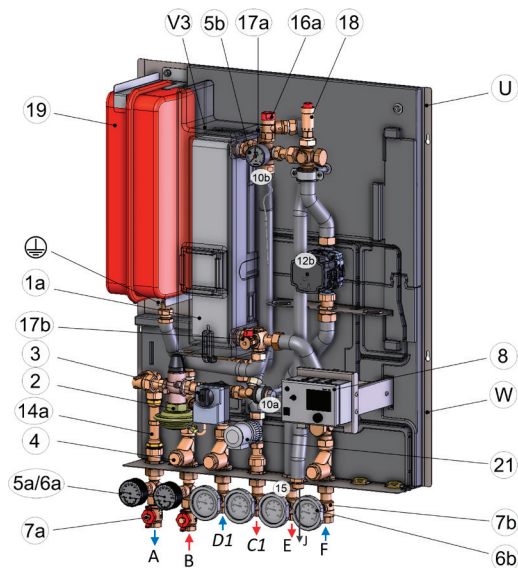

3.2.2.2 Dimensions

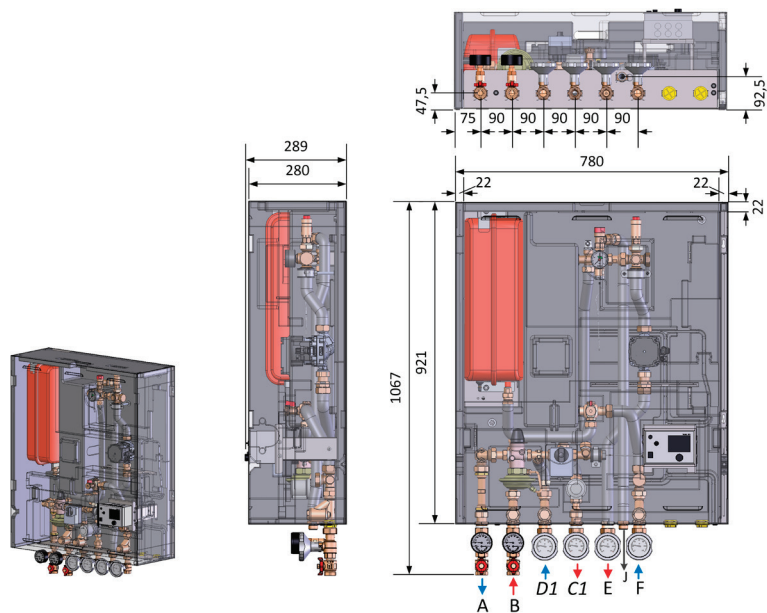

3.2.2.3 Hydraulic diagram

Heat interface unit variant 2 (M10830.210)

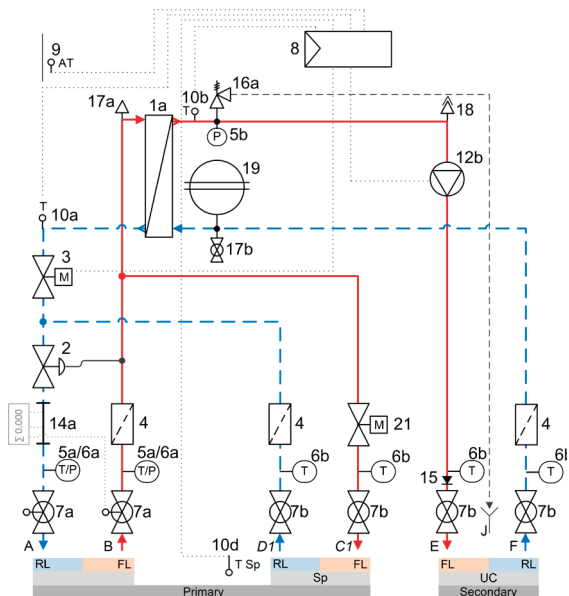

3.2.2.4 Wiring diagram

Heat interface unit variant 2 (M10830.210):

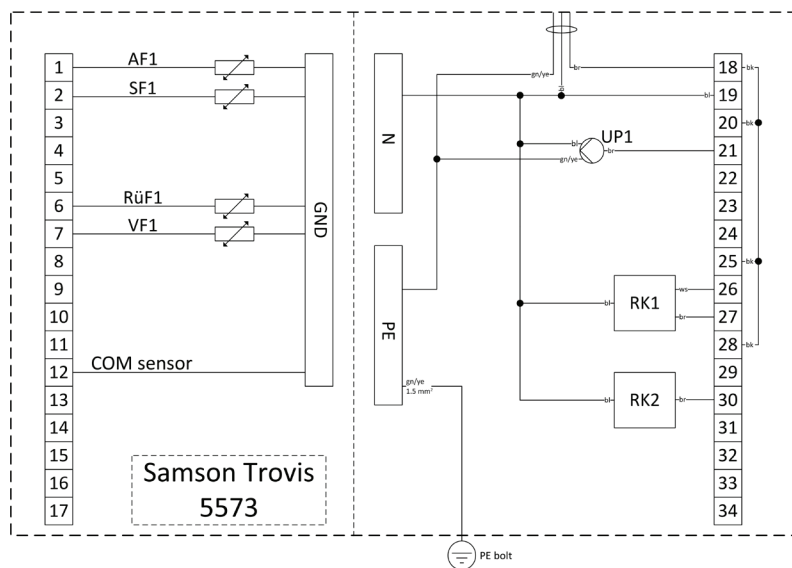

3.2.3 Heat interface unit variant 3 (M10830.220)

3.2.3.1 Components

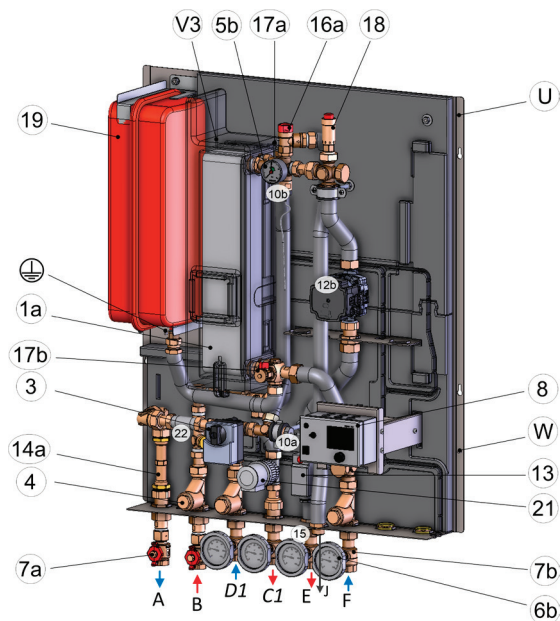

3.2.3.2 Dimensions

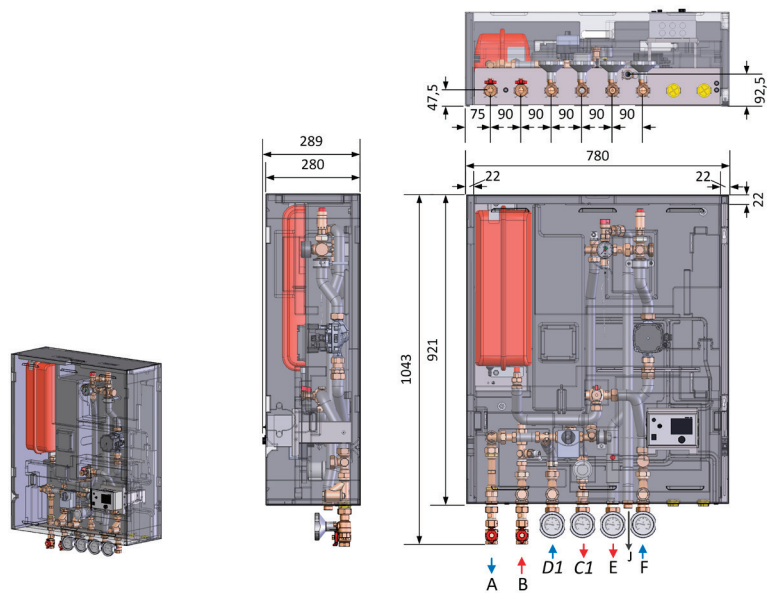

3.2.3.3 Hydraulic diagram

Heat interface unit variant 3 (M10830.220)

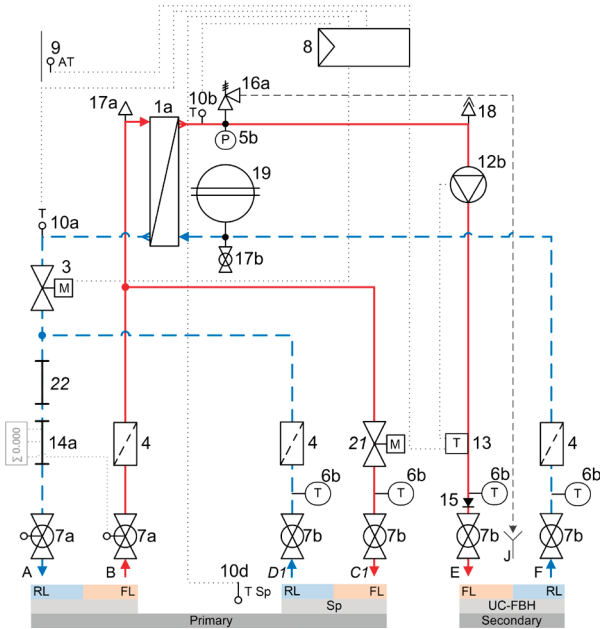

3.2.3.4 Wiring diagram

Heat interface unit variant 3 (M10830.220):

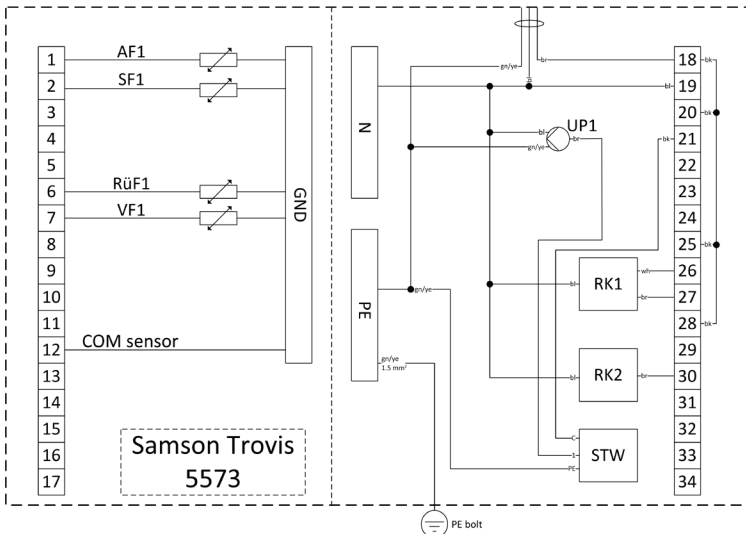

3.2.4 Heat interface unit variant 4 (M10830.510)

3.2.4.1 Components

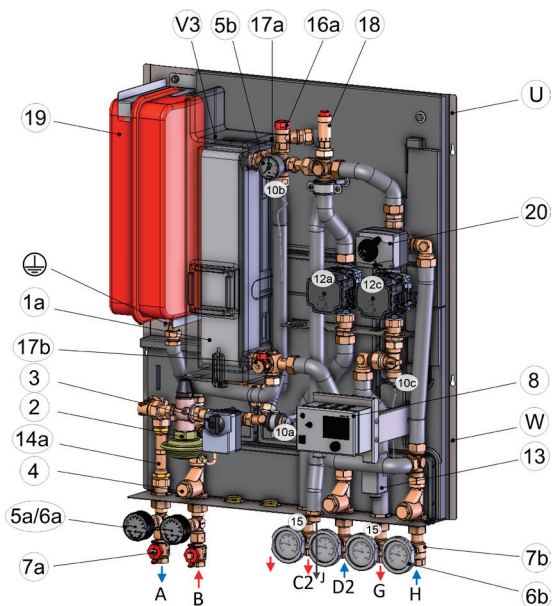

3.2.4.2 Dimensions

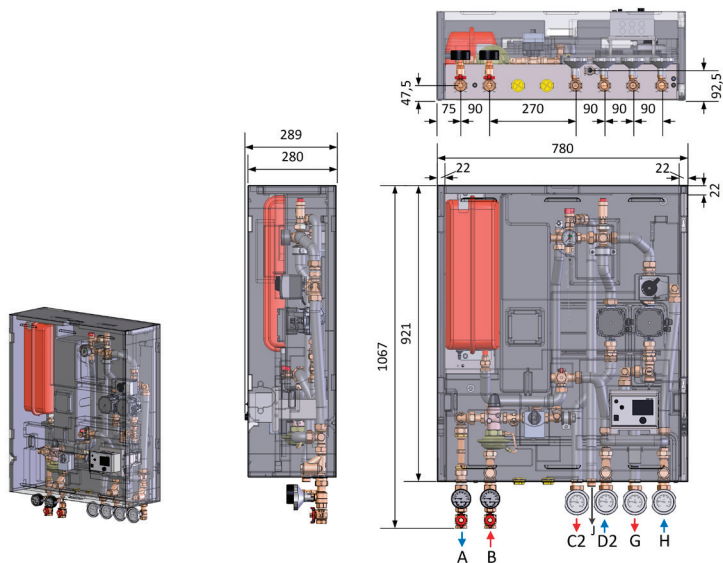

3.2.4.3 Hydraulic diagram

Heat interface unit variant 4 (M10830.510)

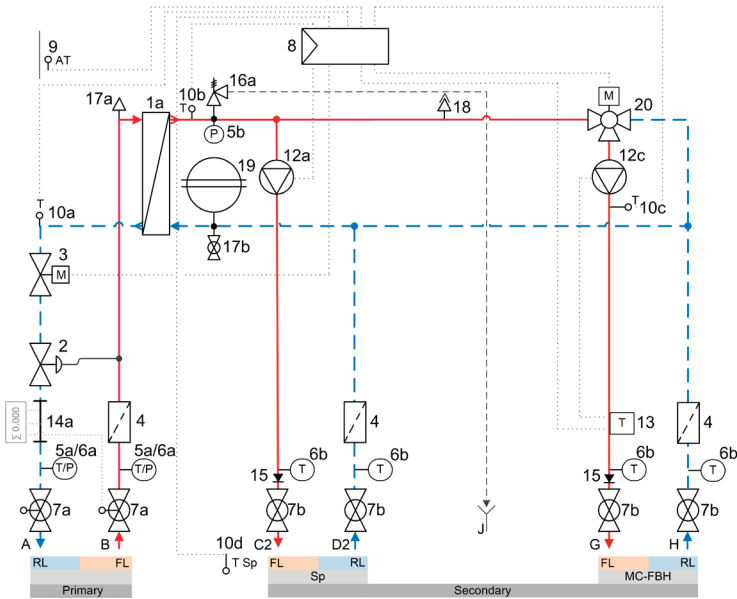

3.2.4.4 Wiring diagram

Heat interface unit variant 4 (M10830.510):

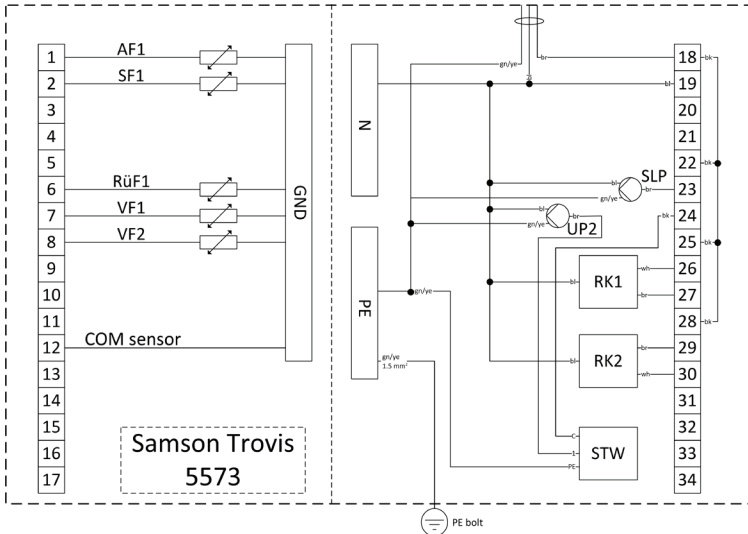

3.2.5 Heat interface unit variant 5 (M10830.520)

3.2.5.1 Components

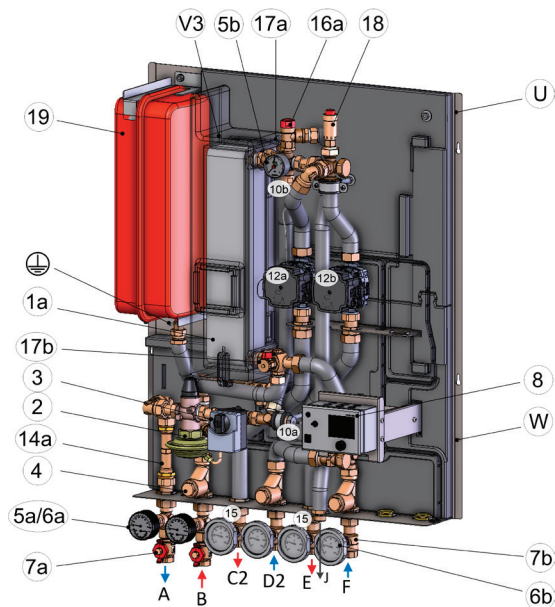

3.2.5.2 Dimensions

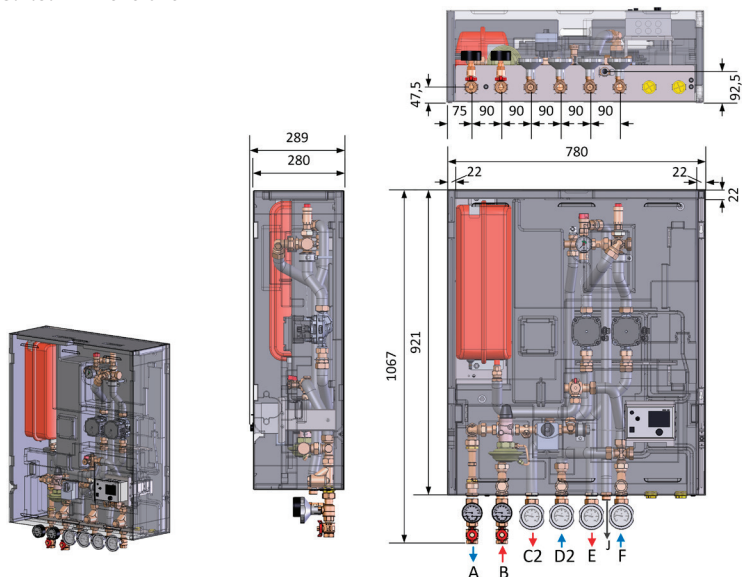

3.2.5.3 Hydraulic diagram

Heat interface unit variant 5 (M10830.520)

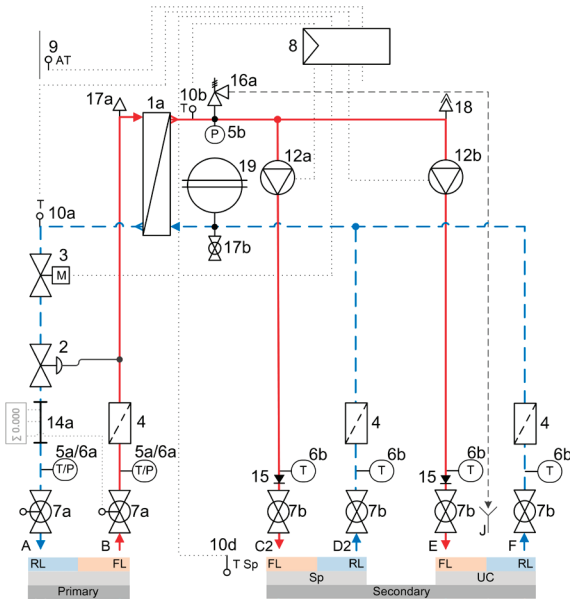

3.2.5.4 Wiring diagram

Heat interface unit variant 5 (M10830.520):

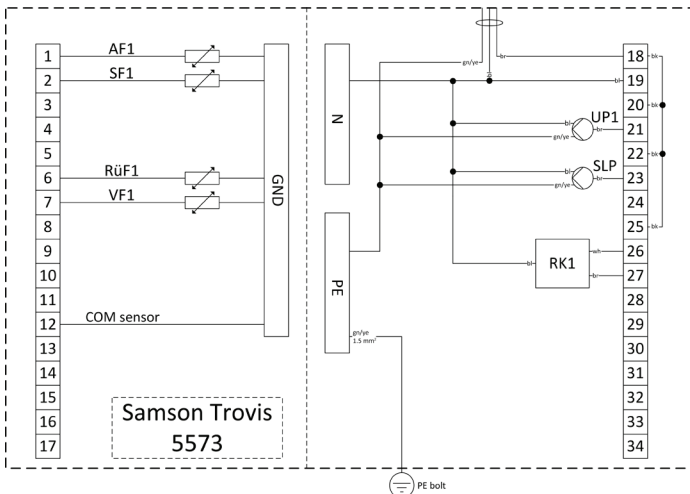

3.2.6 Heat interface unit variant 6 (M10830.530)

3.2.6.1 Components

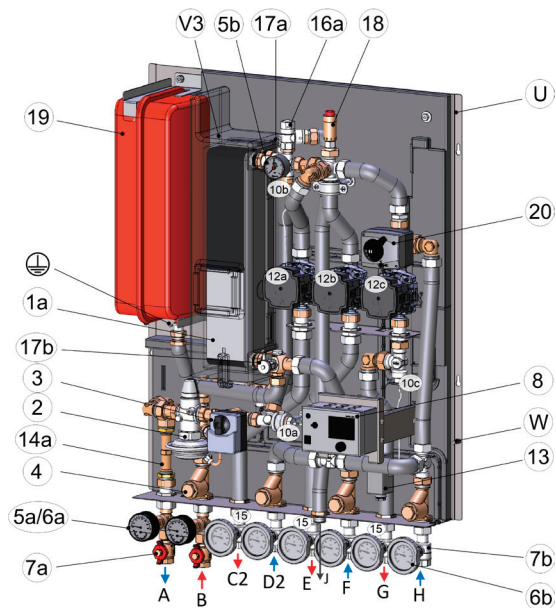

3.2.6.2 Dimensions

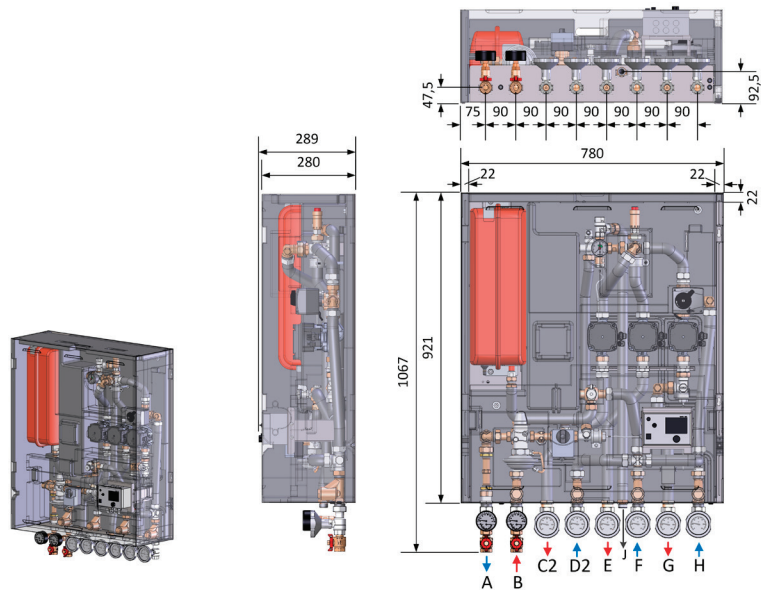

3.2.6.3 Hydraulic diagram

Heat interface unit variant 6 (M10830.530)

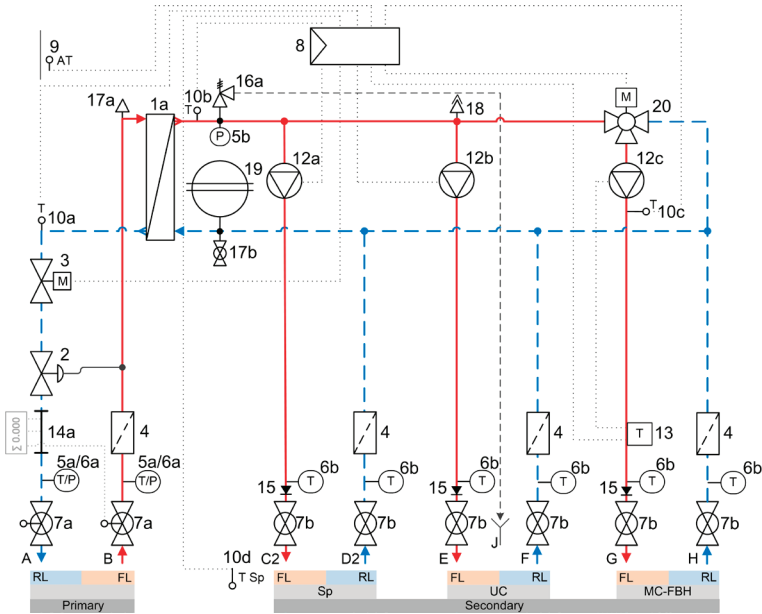

3.2.6.4 Wiring diagram

Heat interface unit variant 6 (M10830.530):

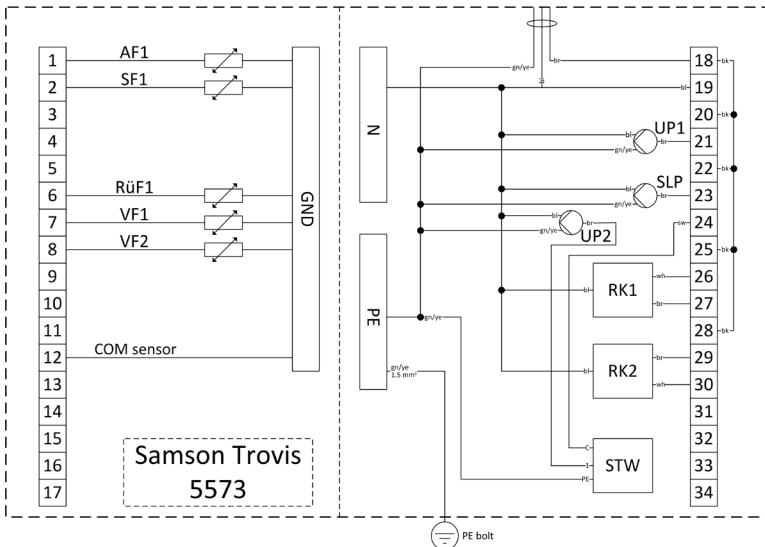

3.2.7 Heat interface unit variant 7 (M10930.010)

See note regarding the thermostatically controlled unit variant: Section 6.6

3.2.7.1 Components

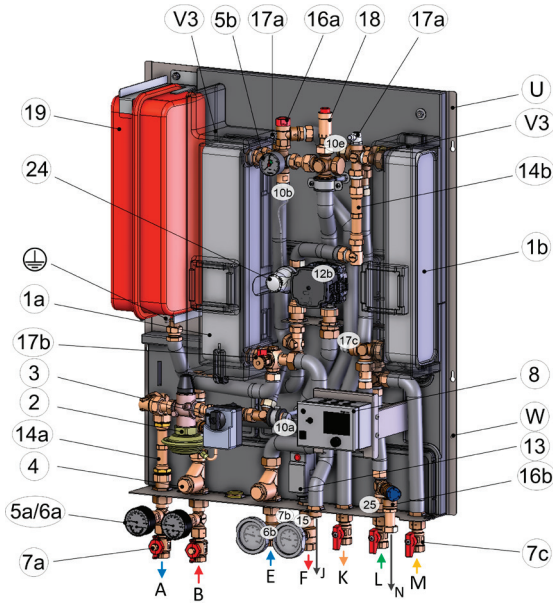

3.2.7.2 Dimensions

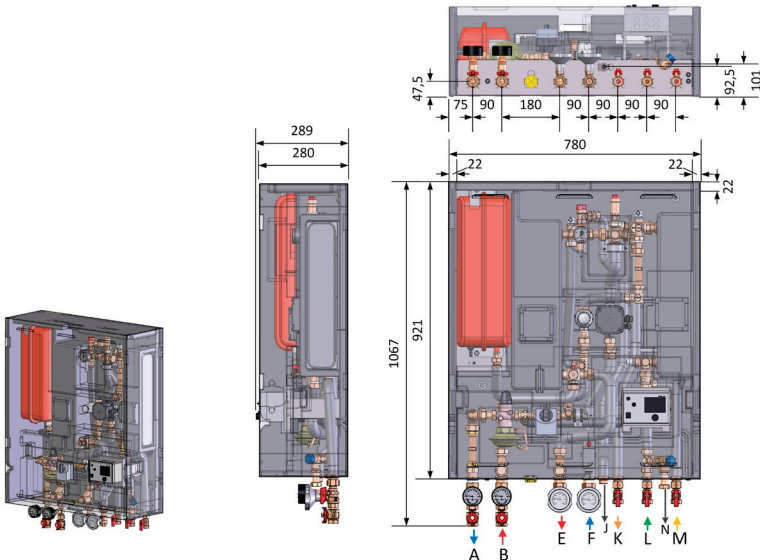

3.2.7.3 Hydraulic diagram

Heat interface unit variant 7 (M10930.010)

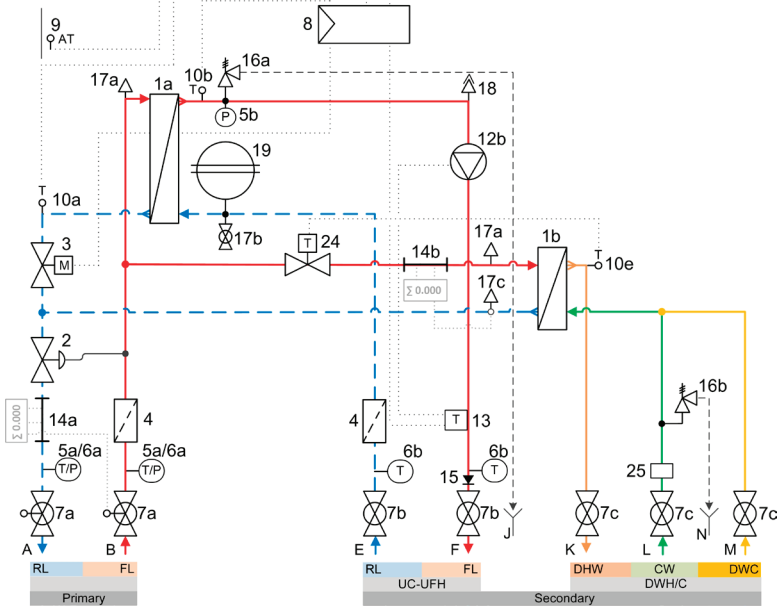

3.2.7.4 Wiring diagram

Heat interface unit variant 7 (M10930.010):

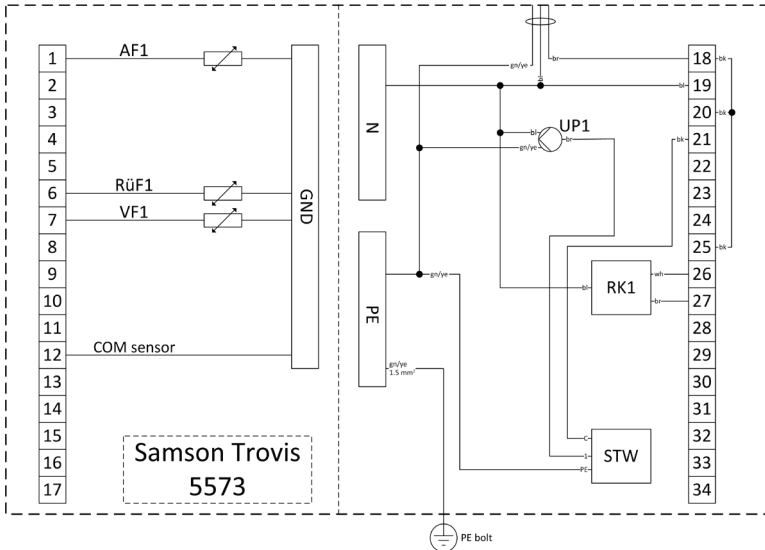

3.3 Legend

Components

Item	Components/elements	Notes
1a		Type B15x40
1b*	Stainless steel plate heat exchanger (copper brazed) with thermal insulation	Type WP24-30 to the DWH in the continuous flow principle
2*	Differential pressure regulator (fixed setpoint value) with volumetric flow limiter	Kv=2.5 in the primary return line
3	Control valve with actuator	in the primary return line
4	Strainer/filter, with male screwed 1" drain (SW 27) and EPDM O-ring	in the respective unit inlets
5a	Gauge with 0 ... 16 bar scale in combination with (6a)	max. 12 bar, primary heating circuit
5b	Gauge with 0 ... 4 bar scale	max. 3 bar, secondary heating circuit
6a	Thermometer with 20 ... 160°C scale in combination with (5a)	max. 120°C, primary heating circuit
6b	Thermometer 0 ... 120°C (corresponding to red/blue scale) in the ball valve handle (7b)	primary tank, secondary
7a	Ball valve ¾" female thread with sensor mount M10x1 from the front	primary Heating circuit
7b	Ball valve ¾" female thread with thermometer (6b) in the handle	primary tank, secondary
7c*	Ball valve ¾" female thread with handle, with DVGW approval	for domestic hot water connection
8	Controller	type Samson Trovis 5573
9	Outside temperature sensor (ATF1)	provided by the customer
10a	RL temperature sensor (RüF1)	Primary
10b	Flow line temperature sensor (VF1)	Secondary
10c*	Flow line temperature sensor MC (VF2)	Secondary
10d*	Tank temperature sensor (SF1)	provided by the customer
10e*	DHW temperature sensor for the Thermostatic Head (24)	Secondary
12a*	Tank charging pump, GF UPM3 Hybrid 15-70, 130 mm (SLP)	Factory setting: CP curve 3
12b*	UC heating circuit pump, GF UPM3 Hybrid 15-70, 130 mm (UP1)	Factory setting: PP AutoAdapt
12c*	MC heating circuit pump, GF UPM3 Hybrid 15-70, 130 mm (UP2)	Factory setting: CP AutoAdapt
13*	Contact thermostat for 12b/12c (as STM)	Factory setting: FL+8K
14a	Adapter primary HFM 1" male thread x 130 mm (or ¾" male thread x 110 mm)	for optional HFM, overall primary
14b*	Adapter primary HFM ¾" male thread x 110 mm	for optional HFM to the DWH

15	Check valve / backflow preventer	in secondary flow line, after pumps
16a		3 bar, secondary heating circuit
16b*	Safety valve ½" x ¾"	6 bar, CW domestic water
17a	Vent stoppers ½"	Primary
17b	Fill and drain ball valve ½" with cap	Secondary
17c	Venting stoppers / sensor mounting option HFM to the DWH	Primary, return line
18	Bleed valve 3/8" with shut-off	Secondary
19	MAG 12 litres with refill valve	in the secondary return line
20*	Mixer with servomotor	for MC
21*	Two-way valve with actuator	for primary tank
22*	Differential pressure regulator adapter (¾" male thread x 65 mm)	primary return line
24*	Temperature controller 40-70°C with TH type startec 4 M30x1.5 and 2 m coil sensor to (10e)	to the DWH in the continuous flow principle
25	Flow limiter 17 L/min, identifying colour: brown	

Connections

A	RL, BV: ¾" female thread	Primary	DN20, ¾"
B	FL, BV: ¾" female thread		
C1/C2*	FL, BV: ¾" female thread	Tank	
D1/D2*	RL, BV: ¾" female thread	primary/secondary	
E*	FL, BV: ¾" female thread	UC	
F*	RL, BV: ¾" female thread		
G*	FL, BV: ¾" female thread	MC	
H*	RL, BV: ¾" female thread		
J	Open safety valve outlet FL, ¾" MT flat sealing.	Secondary	
K*	DHW, BV: ¾" female thread	Domestic water, secondary	
L*	CW, BV: ¾" female thread		
M*	DWC, BV: ¾" female thread		
N*	Open safety valve outlet CW, ¾" FT flat sealing with UN		

* Depending on unit variant

4. Installation

General assembly instructions

- Sufficient space for installation, maintenance and service
- Installation on a suitable load-bearing wall with appropriate fastening materials
- Re-tighten all joints and screw fittings during a pressure test or following the initial heating cycle

General assembly instructions for protecting the pump

When installing the station, please also refer to the instructions of the pump manufacturer:

- Only install a pump shaft horizontally
- Note the minimum supply pressures: e.g. 0.5 bar at 95°C; e.g. 1.08 bar at 110°C
- Only operate the pump when filled with water and bled
- Do not additionally insulate the connection box (the pump electronics must be kept cool)

4.1 Installation instructions for mounting, connecting and cable routing options

Example figures:

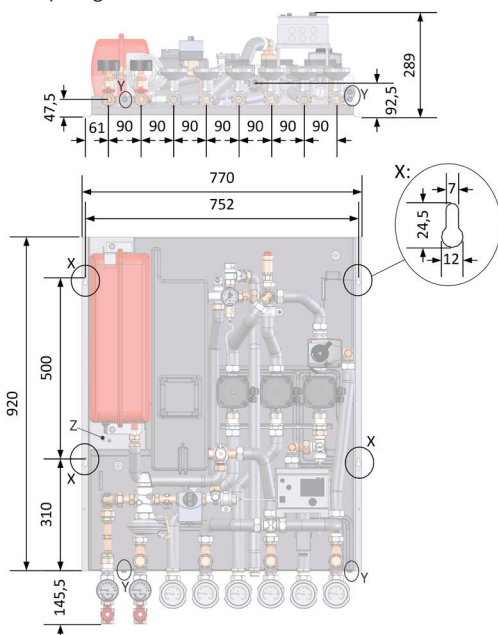

Legend:

X) - Key holes for wall mounting

Y) - Openings and options for cable routing

Z) - PE connection option on the metal base plate

Note: For the hydraulic connections, see the relevant section (depending on the station variant)

4.2 Installation instructions

The stations may only be installed and commissioned by qualified specialists in consultation with the relevant district heating provider. The connecting pipework must be selected to ensure it satisfies the statutory requirements with regard to material, pressure, temperature and chemical resistance (see “Technical Connection Conditions” of the local district heating supply company).

The pipework must be connected so that no tension forces are exerted on the heat interface unit. All internal and external connections must be checked prior to commissioning and, following the initial heating period for leak-tightness, tightened and defective seals replaced if necessary.



Due to its extreme weight, the unit must be transported and positioned using suitable means of transportation.
Several people should always assist with lifting the unit.



Notes on lifting:

Please do not lift by the pipework.

The following lifting points can be used for this:

- Moulded parts directly adjacent to the mounting brackets
- Connections on the heat exchanger
- Ball valves / dirt traps
- Base plate panel

The installation location must be selected to ensure free access to the unit. If the system is wall-mounted, the masonry must be sufficiently solid (DIN 1053 and structural analysis).

The safety valves' vent lines must be arranged to ensure that no-one can be put at risk from vented hot water or steam.

The installation location must be frost-free and dry. The specified threshold values must not be exceeded.

Room temperature - minimum:	+5 °C (frost-free)
Room temperature - maximum:	+40°C (summertime operation)
Maximum air humidity:	65%

It is important to ensure that no oxygen enters the heating-circuit water. There is a particular risk of oxygen diffusion in underfloor heating systems (plastic pipes) and in reinforced hoses. This must be prevented by suitable means. Otherwise the system may become blocked due to corrosion or microbiological growth.

Regular inspection will prevent the heat exchanger from becoming blocked as well as identifying leaks caused by unwanted vibration. Also check the heat interface unit connection values against the heating system design data. Follow the instructions provided in the section entitled "intended use". Before commissioning the unit, read the operating instructions provided. Improper operation will invalidate the warranty.

Connection to the domestic water system:

The heat interface unit may only be connected to the domestic water system by specialist companies authorised by the local domestic water supplier. The heating system must only be filled using a DVGW-approved filling device (see also VDI 2035). Disconnect this filling device as soon as filling is complete.

Electrical connection:

Electrical connection work may only be carried out by qualified electricians. The VDE guidelines and the provisions of the responsible energy utility company must be observed.

The heat interface unit must be protected against reverse electrical polarity. The customer must install a mains isolation switch for the purpose of inspection and repair work. We recommend installing this switch close to the unit itself.



The unit must be connected and grounded to earth.

A terminal is identified on the base plate for this purpose.

If a controller is pre-installed at the factory, this will already be connected.

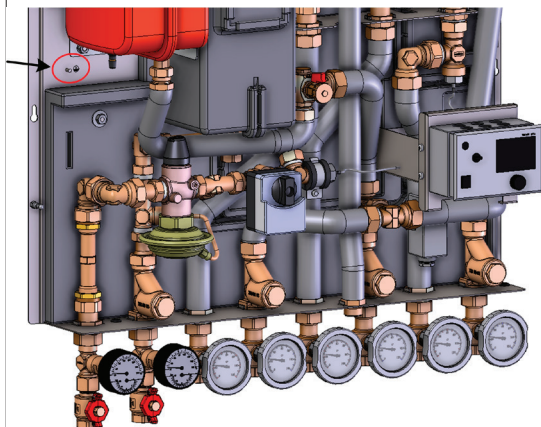
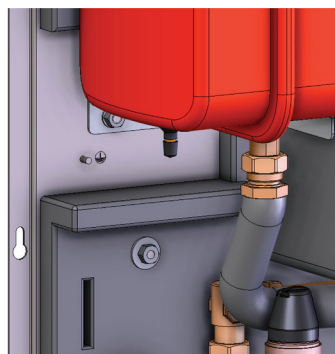

Sensor cables and mains voltage cables must not be laid alongside one another in the same cable duct over long distances. Outside sensors and room sensors must be installed in accordance with the heating systems regulations. Please assemble storage tank sensors in accordance with the tank connection diagram. Please note that the circuit diagrams provided supplement the manufacturer's operation instructions.

Read the original operation and installation instructions carefully before beginning work. Please keep them in a safe place. You will be charged for their replacement.

5. Individual components

5.1 Electronic system controller

For controlling the primary side, included are 2x temperature sensors (primary return line and secondary flow line), a controller from Samson, type Trovis 5573, is mounted and electrically connected at the factory. The secondary-side control circuits are also connected and configured (corresponding to the station variant).



ME-80592.018

The controller can control up to three secondary supply circuits: 1 x mixed, 1 x unmixed heating circuit and 1 x heating circuit for hot water preparation.

Please note the separate instructions for the controller.

Below are the **wiring diagrams** for the primary and secondary side / circuits (pre-wired at the factory, corresponding to the station variants).

Note: Domestic hot water tank and outside temperature sensors must be installed by the customer if required.

Controller factory setting:

- Primary: 75°C / 47°C
- Secondary*:



Domestic hot water tank:	65°C / 45°C (priority)
UC:	65°C / 45°C
MC:	37°C / 30°C

* Depending on heat interface unit variant

5.2 Primary components

5.2.1 Relay valves and controllers

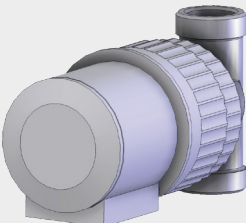

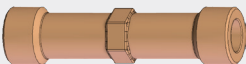
Primary fittings in the flow to the DHW*

Item No.			ET No.
(21)*		<p>2-way valve with 2-point actuator to the primary domestic hot water tank charging system</p> <p>Type Danfoss, straight-way valve 3/4" male thread, VMT, Kvs=1.5 with ABV-NC actuator</p>	ME-80590.45
(24)* (10e)*	<p>Coil sensor Stainless steel in the DHW</p> 	<p>Temperature controller with thermostatic head 40 ... 70°C and coil sensor in stainless steel for DHW in the continuous flow principle</p> <p>Thermostatic valve body DN15, Kvs = 2.7 in straight pattern</p> <p>with thermostatic head (TH) type startec 4, M30x1.5 and 2 m screw-in temperature sensor T1/2"</p>	<p>Valve: ME-80593.11</p> <p>Thermostatic Head: ME-80593.11K</p>
(14b)*		<p>Adapter for optional heat meter to the DHW in the continuous flow principle</p> <p>3/4" MT x 110 mm MS CW617N</p>	

*Depending on unit variant

Note: Please follow the corresponding manufacturer-specific instructions in each case.

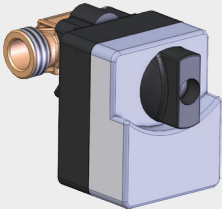
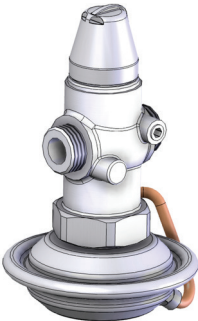
Primary fittings and components in the return line

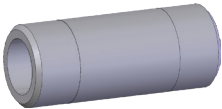
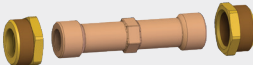



Item No.		ET No.
(3)		<p>2-way ball valve with 3-point 230 V actuator</p> <p>Type Belimo, R408DK DN10; Kvs=1.6; 3/4" male thread with actuator TRD230-007; 230V; 1.6 Nm</p> <p>ME-80594.06 ME-80594.07</p>
(2)*		<p>Differential pressure regulator / flow limiter (with fixed setpoint value)</p> <p>Type Danfoss, AVPB-F, PN16, DN15, Kvs=2.5; fixed differential pressure with setting for: 0.2 bar 0.3 bar</p> <p>ME-80590.28 ME-80590.54</p>
(10a)		<p>Screw-in temperature sensor T½" NL=45</p> <p>ME-10576.113</p>
(22)*		<p>Adapter for differential pressure regulator / flow limiter</p> <p>3/4" MT x 65 mm, galvanised steel, thread DIN 228</p>
(14a)		<p>Adapter for optional heat meter</p> <p>3/4" MT x 110 mm MS CW617N and reducing pieces 1" male thread x 3/4" female thread for 130 mm built-in length</p>

*Depending on unit variant

Note: Please follow the corresponding manufacturer-specific instructions in each case.

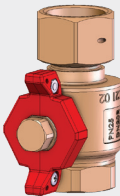
5.2.2 Shut-off, thermometer and manometer and components

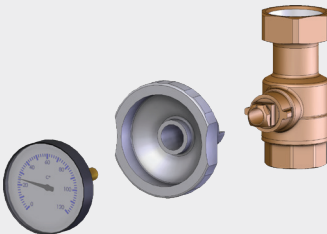
Primary fittings and components in the flow line and return line

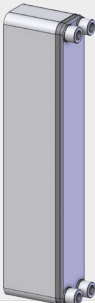
Item No.			ET No.
(5a)		District heating circuit shut-off valves Ball valves ¾" FT x ¾" UN with mounting option for sensor (M10x1) from the front (for optional heat meter) and with sealing option	ME-61881.24
(6a) (7a)		District heating circuit thermometer/manometer combination Display: 20...160°C/0...16 bar, ½" male thread	ME-45246.3
(6b) (7b)		Shut-off valves for primary tank charging circuit* Thermometer 0...120°C (blue/red), removable ball valve handles (¾" FT x 1" UN, without RV)	Ball Valve without RV: ME-61887.56 Thermometer red/blue: ME-58071.504/ ME-58071.505
(17a), (17c)		Drain plugs* ½" 10 bar	as spare part: Part of ME-10000.02
(1a) (1b)*		Heat exchanger: Type B15x40 Type WP24-30 (to the DHW)	ME-10230.62 ME-10232.59

*Depending on unit variant

Note: When operating the unit, secure ball valves against accidental closure (e.g. by removing the handles).

5.3 Secondary components

5.3.1 Space heating circuit / tank charging pump

Item No. 12a, b, c) type Grundfos UPM3 Hybrid 15-70 130 PWM (ET No.: ME-45101.76)

The additional enclosed documents concerning the pump must be observed.
Depending on the system, the pump must be adjusted/adapted to the requirements on site.

Electrical data:

Power supply:	230 V, 50 Hz	
Speed	P1 [W]	I1/I [A]
MIN	2	0.04
MAX	53	0.52

Technical data:

Operating pressure:	max. 1.0 MPa
Minimum supply pressure:	0.05 MPa
Media temperature:	+2 to +110°C



The LEDs (one red/green and 4 yellow) indicate the corresponding operating/alarm status.
Please observe the respective information provided by the pump manufacturer.

Performance characteristics:

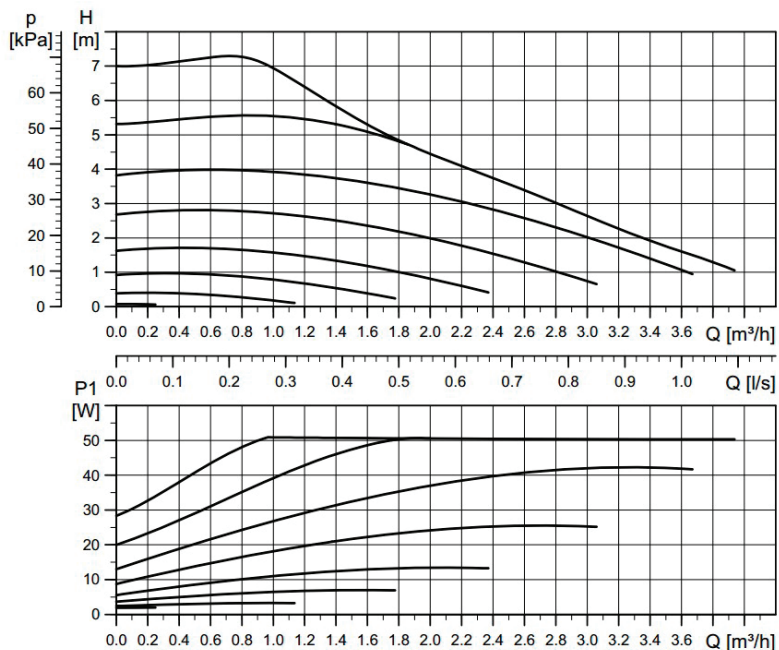

Note: Pump performance data not for spare parts

5.3.2 Shut-off valves

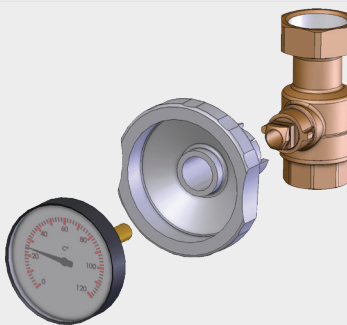
Item No.	Shut-off valves for secondary tank charging circuit and for heating circuits*	ET No.
(6b) (7b) (15)	 <p data-bbox="213 592 773 652">Thermometer 0...120°C (red/ Blue), removable ball valve handles (3/4" female thread x 1" UN, with RV in flow line ball valve)</p>	<p data-bbox="785 256 1003 344">Ball Valve with backflow limiter: ME-61887.55</p> <p data-bbox="785 384 1003 472">Ball Valve without backflow limiter: ME-61887.56</p> <p data-bbox="785 472 1003 560">Thermometer red/blue: ME-58071.504/ ME-58071.505</p>

*Depending on unit variant

Backflow limiters (backflow limiter) are integrated into the secondary flow line ball valves. These are individually marked (see sticker). The backflow limiter can be opened manually by turning the BV's rotating handle by approx. 45°.

The following illustrations show the position of the handle (without thermometer) and the Ball Valve shaft.

45° (for flushing, draining): Ball valve open, BP open

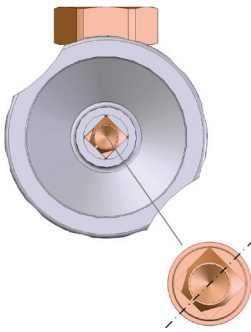

for flushing / filling, see Section 6.1

0° (for normal operation): Ball valve open, BP working

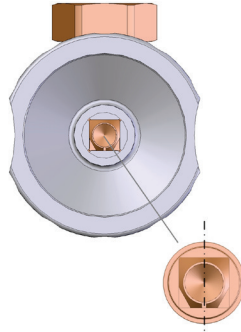



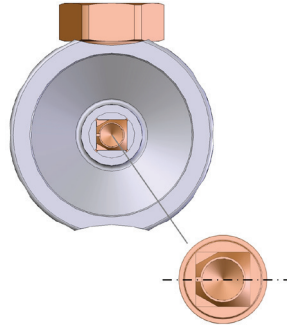

90° (for service): Ball valve closed, BP open



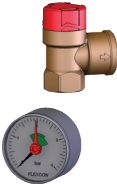

Notes:

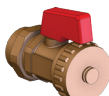
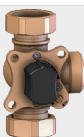
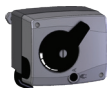
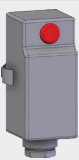
- When installing the ball valves (BV) on the station, note the corresponding direction of flow and backflow limiter in the Ball Valve
- When operating the unit, secure ball valves against accidental closure (e.g. by removing the handles) if necessary.

5.3.3 Other components

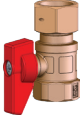
Item No.	Other components in the secondary circuit	Descriptions	ET No.
18		Flexvent bleed valve 3/8" x 1/2" with shut-off option installed in the heating circuit flow line.	ME-67502.1
16a 5b		Prescor safety valve 3 bar 1/2" x 3/4" and gauge 0...4 bar with centred connection, installed in the heating circuit FL, stainless steel	ME-69010.01 ME-69021.10
19		Flexcon, flat expansion vessel 12 litres with check valve, primary pressure 0.8 bar, installed in the heating circuit return line. Note: Pre-punched openings in the side station housing parts mean that it is also possible to connect an external expansion vessel.	ME-45200.28
17b		Fill and drain ball valve 1/2" with cap installed in the heating circuit return line.	ME-65051.3
20*		3-way mixer 1"	ME-66617.3
		Servomotor 140s, 6Nm, 230V, grey, 2m cable	ME-66341.5
13*		Contact thermostat 16 (2.5)A/230V, adjustable internally 20 ... 90°C, installed on the heating circuit FL and connected electrically as an STM to the relevant pump.	ME-45160.01
16b*		Prescor B domestic water safety valve 6 bar 1/2" x 3/4" installed in the domestic cold water.	ME-69030

25*		Flow rate limiter 17 litres/min (identifying colour: brown), installed in the domestic cold water.	ME-10240.801 with ME-10240.805
7c*		DVGW, WRAS domestic water ball valve 3/4" female thread x UN 3/4" female thread with red removable handle	ME-61801.22
10b 10c*		Screw-in temperature sensor T1/2" NL=45	ME-10576.113

*Depending on station variant

The outlet lines of the safety valves run from the unit housing downwards and must not be sealed.
Note: the latest manufacturer instructions for the components in question should also be considered.

5.4 Filter/strainer in primary/secondary circuit

The filter/strainer in the unit's primary flow line and secondary return line protect the system against sludge and impurities. The filter/strainers can be cleaned by flushing them. This is done by removing the respective plug and taking out the filter. The unit must be isolated and depressurised prior to disassembly.

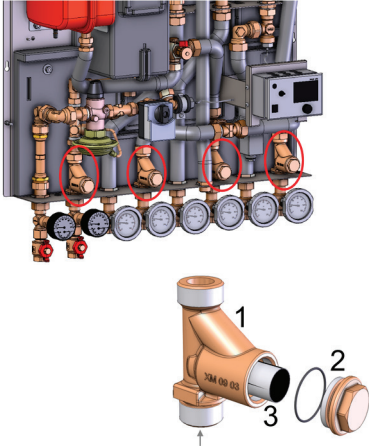

Legend:



1- filter/strainer 1" housing
2- Plug 1" SW27 with O-ring*
3- Filter*

↑- Direction of flow
Flow line primary side or
Return line secondary side

* As spare parts:
Part of ME-10000.02

- Once the work is complete, re-open the shut-off valves and use the bleeding devices to vent the unit.
- Perform a leak-tightness check.

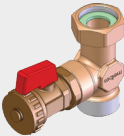
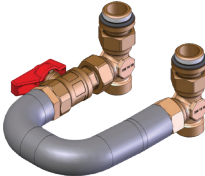
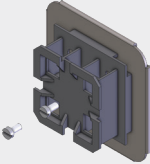
5.5 Accessories

Fig.	Optional accessory parts	Art. No.
	LogoMini drainage set	M10730.010
	LogoMini flushing set	M10730.030
	HFM counter holder	M10730.020
	Heat flow meter from the "HeatSonic" or "LogoSonic" series	See website or the latest product catalogue

5.6 Installation of optional heat meters in the primary heating circuit

A heat meter (HFM) may only be installed once the entire heating system has been flushed through. LogoMini G2 heat interface units are fitted with adapters ($\frac{3}{4}$ " with 110 mm construction length) for heat meters, which must be removed before the optional heat meters are installed.

Note regarding 14a: After removing the two reducing pieces and seals, HFM with a 1" connection and 130 mm construction length can also be installed in the same place.

Warning, risk of scalding from hot water:

The built-in meter is a pressurised component! It must be installed only by trained specialist personnel. The individual manufacturer's instructions for the heat meter in question must be observed.

Procedure (example):

- Close all 7a or 7b* shut-off valves on the primary side.
- Lower the system pressure by opening the bleeding devices (e.g. 17a).

WARNING: Water may leak from the system.

(The station can be drained using the optional fill and drain ball valves.)

- Then loosen the screw fittings on adapter 14a or 14b*.
- Remove the adapter and insert the heat meter and screw it into place (using the appropriate seals).

NOTES:

- The possible operating and ambient temperatures must be checked for the HFM in question.
- Certain components in the heat meter may be equipped with a lithium battery. Note the instructions regarding operation and transport for this.
- Note the directions of flow (see arrow) for the flow sensor.
- In the case of heat meters with removable counter, these can be attached to the relevant heat insulation shell on the plate heat exchanger (HFM a/b*) using the optional HFM bracket.
- Properly install the appropriate flow line and/or return line temperature sensor for the heat meter. Note the position of the sensor and if necessary, replace the stopper for (S1) or venting stopper* (17c) with corresponding sensors / sensor holders.

Example figure (in this case, heat interface unit variant 7 with separate PHE to the DHW):

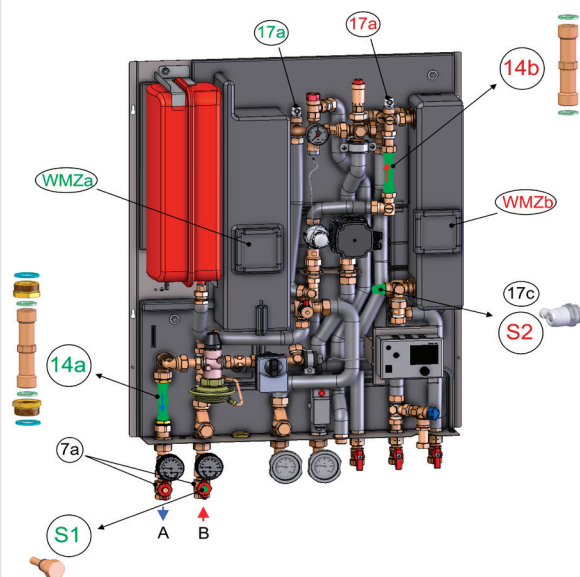

To the temperature sensors:

FL item **S1** for HFM **14a**:

- For measuring the entire heat volume (space heating and storage tank charging system*)

RL item **S2*** for HFM **14b***:

- For measuring the proportion of heat volume to the DHW in the continuous flow principle

Note:

When routing the sensor lead, ensure electromagnetic compatibility.

*According to the unit variant

- Once the work is complete, re-open the shut-off valves and use the bleeding devices to vent the unit.
- Perform a leak-tightness check.

5.7 Spare parts

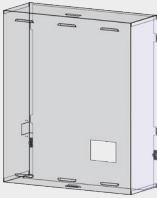
Designation	Order No.
Surface-mounted cover, galv. sheet steel (HxWxD) 920x780x280 mm incl. rapid closures	ME-10203.785
	
Sealing set 3/4" and 1"	ME-43.6615
Stainless steel corrugated tube set DN20 for secondary circuit with thermal insulation	ME-46122
Stainless steel corrugated tube set DN16 for secondary circuit with thermal insulation	ME-46123
Stainless steel corrugated tube set DN16 for primary circuit with thermal insulation	ME-46123F
Service kit for heat interface unit connection 3/4" (incl. filters, O-rings, drain plugs and seals)	ME-10000.01
Service kit for heat interface unit connection 1" (incl. filters, O-rings, drain plugs and seals)	ME-10000.02

6 Commissioning

Before using our products, they must be checked for suitability for the respective planned application.

Please bear in mind the water quality at the installation location, particularly for domestic water applications.

In the case of critical domestic water qualities, please take suitable measures where necessary (e.g. water treatment) in order to prevent functional impairment and/or damage, e.g. corrosion damage. In particular, please check the permissible limit values, e.g. for electrical conductivity, the pH value, the local hardness level and the ammonium concentration.

Further information can be found in the "Docfinder" area at: www.flamcogroup.com

"Information on water quality, preventing limescale and stone formation and corrosion in systems with decentralised hot water preparation".

After installation or maintenance work and before commissioning, all water lines must be connected according to the existing system design.

Ensure that all materials, tools and other equipment required for the models have been removed from the device's working area.

All joints and connection points must be tightened before commissioning and pressure testing. Before the first commissioning, the system must be checked for leak-tightness, the correctness of the hydraulic connections and precise and correct electrical connection. In addition, as required in accordance with DIN 4753, the system must be flushed correctly. Commissioning must be carried out by a specialist, and recorded in writing. In addition, the settings must be recorded in writing. The technical documentation must remain with the equipment.

6.1 Flushing and filling

Note for the installer:

Heating systems must be flushed prior to commissioning in accordance with local regulations, such as DIN EN 14336, VOB ATV C DIN 18380 or VDI 2035. After the system has been filled for the first time, the recirculation pump must be left to run for about 1 hour before it can be switched off for a longer period.

Flush the system carefully before filling.

Check all joints and connections and tighten them if necessary.

Ensure all threaded joints are locked tight.

Once the system has been filled, bleed the unit and refill the heating system as required.

6.2 Initial start-up

The leak tightness of the unit's connections must be checked and the connections must be re-tightened if required. When re-tightening the connections, always **counter-hold** with a suitable tool!

Only commission the unit once it has been flushed, filled and a pressure test carried out.

All heating and domestic hot water installation work must be complete.

Vent the system every so often during the station commissioning process.

Warning: Note the heating's system pressure and top it up if necessary.

Commissioning must be carried out by a trained expert and the settings must be recorded in a log (for subsequent maintenance work).

The relevant applicable operating instructions (for the controller, pump, servomotor, etc.) must also be observed!

Please observe the instructions, benchmarks and settings for the unit when commissioning.

The actuators must be connected to the power supply at all times when the system is full, especially for the pumps.

The following requirements must be met for successful commissioning:

- All components of the system are installed and assembled.
- The entire system is leak free.
- All necessary electrical connections have been made.

6.3 Heating system

Commission the system according to the following points (general instructions): (The system is disconnected from the mains and empty.)

1. Close the shut-off valves on the primary and secondary sides.
2. Flush, fill and bleed the primary side. Check for leaks.
3. Flush, fill and bleed the secondary side. Check for leaks.
4. Check the heating system pressure and top up with water as required. Factor this in for systems which include domestic water heaters.
5. When the system is leak-tight, slowly open the primary and secondary side shut-off valves.
6. Commission the unit's electrical system (VBG 4). Ensure that it is not possible for the pumps to operate without water or when the shut-off valves are closed.
7. Perform a function check of the field devices.
8. Adjust the flow rates for the domestic water heater, heating system, etc. Programming the digital controller. Please note that the controller is pre-adjusted in the factory. Adjustment diagrams/data are provided by the system operator.
9. Check the safety devices. (Provide proof, if necessary) Train all operating personnel, particularly with regard to safety devices and conduct in the event of danger.
10. Seal system components in accordance with the technical connection conditions.

Only use an approved filling device when filling the system from the domestic water supply. Comply with all local water quality requirements (cf. VDI 2035).

Fill the station slowly with the bleeding devices open to ensure that all the air has been fully expelled. Bleed the recirculation pumps according to the manufacturer's instructions.

6.4 Domestic water heater

In order to optimise the hot water preparation and to protect the domestic water heater from limescale, it is necessary to adjust the individual flow rates and temperatures (controller). This is based on the calculated value. First set the theoretically required flow rate (design specification). Check this setting when the system is in operation and adjust as required.

Warning!

Please make this adjustment carefully as too high a temperature could cause the following damage, among other examples:

- Accumulation of limescale in the heat exchanger
- Limescale deposits in the domestic water heater and pipework and fittings.
- Risk of scalding at extraction points from very high temperatures
- Dezincification of galvanised pipes (comply with DIN 1988)

Comply with the respective manufacturer's installation, operation, maintenance information and the safety instructions for the domestic hot water tank.

The domestic water heater must additionally be protected by a safety temperature limiter.

6.5 Adjusting the digital controller

If the heat interface unit is supplied with a digital controller, the controller controls the system according to the outside temperature or the demand for domestic water, while simultaneously restricting the return temperature on the primary side.

Note:

Depending on the configuration of the controller, it is possible to prioritise the hot water or run it in parallel with the heating circuit.

In the event of a power failure, or if the unit is switched off (maintenance/troubleshooting), the programmed data is retained with the exception of the time (according to the controller manufacturer).

Please consult the controller manufacturer's operating instructions in order to adjust the controller.

The controller of the primary side is pre-adjusted at the factory (only the primary circuit). The controller of the secondary side (at the customer) must be adjusted on site during commissioning. The operating instructions of the controller must also be followed for this.

6.6 Notes on thermostatically controlled station variant 7 (M10930.010)

With a thermostatically controlled station, fluctuations in the outlet temperature may occur in the initial phase of hot water preparation (start phase) before a stable hot water temperature is reached after a few seconds. This starting behaviour is system-dependent and can be attributed to the control characteristics of the thermostatic valve (P controller). It does not represent a defect or deficiency in your unit.

To minimise the effects, it is therefore important to carry out the commissioning of the unit correctly and to set all adjustment values according to the heating system's planning and design parameters.

Tips for minimising fluctuations in hot water preparation:

- Set the differential pressure regulator and the thermostatic valve of the station exactly according to the design documents. Then check the primary flow rate during hot water preparation via a heat meter.
- Excessively high heating medium or flow line temperatures at the station will make temperature fluctuations more likely during hot water preparation. If necessary, reduce the flow line temperature in the heating system to a practical minimum.
- Set the hot water temperature on the thermostatic head accordingly (recommendation: 50 to max. 60 °C). The greater the difference between the set domestic hot water temperature and the flow line temperature of the heating system, the less favourable the control dynamics and thus the starting behaviour.
- Avoid unnecessary readjustment at the draw-off points! Open the domestic hot water tap and wait until a stable temperature has been reached. Then slowly readjust the temperature at the tap.

7 Maintenance and service

Inspection, maintenance and service work on the Heat Interface Unit and heating system must be carried out and documented (in accordance with the relevant inspection guidelines) by a trained expert (installation company or Flamco customer service).

The condition of parts must be checked and these must be replaced if necessary. The unit must be checked regularly for leaks.

During maintenance work, the safety instructions and residual dangers (see Section 1) must be observed!

For recommissioning, please observe the points in Section 6.2.

When using nitrite-free anti-freeze and corrosion protection agents with an ethylene glycol base, please pay close attention to the manufacturer's documentation, particularly with respect to the concentration and specific additives.

Different water qualities and degrees of hardness can also influence the service life of individual components of devices. Therefore, regular inspection and maintenance (according to current technical rules) should be carried out annually to maintain the system's efficiency and functional safety.

If you have any questions, please contact your installation company or Flamco customer service.

Extract from DIN 4747-1:

"The operator of domestic heat interface units is obligated to have the system maintained at regular intervals by a qualified person. At a minimum, the maintenance of the systems comprises the inspection of the safety equipment and the central control and regulation devices. The maintenance must ensure the system is in a technically functional state as a minimum."

Regularly monitoring and adjusting the settings will always ensure the optimum operation of the station, which will save costs (energy, repairs, additional heat sources) and increase the service life of your system.

Scope of maintenance:

- Perform a visual inspection of the system for leaks.
- Check filter/strainers and clean if necessary (Caution: close shut-off valves, depressurise the system, be aware of high temperatures!)
- Record and compare planned and actual values
- Check all measuring instruments in the station
- Check the functioning of all safety valves
- Check and if necessary, adjust the flow rates; check the recirculation pumps
- Check cables for potential damage (mechanical/thermal) and potential equalisation
- Check the control sensor is seated correctly
- Function check of safety devices (safety temperature limiter/monitor, temperature controller, safety temperature monitor for underfloor heating, etc.)
- Perform a function check on the controller including the actuators.
- Bleed the system.
- Check the pre-charge pressure of the expansion vessel
- Check the retaining fixture, stability and alignment of the system
- Tighten all threaded joints and exchange faulty seals as required.
- Check the functioning of the protection anode in enamelled domestic hot water tanks. Exchange defective or worn anodes (by trained personnel)
- Check the domestic hot water tank for deposits and contamination.
- Clean the domestic hot water tank (by specialist personnel).

7.1 Information regarding domestic water hardness

The propensity for natural water to form limescale deposits depends, among other things, on various factors such as the concentration of calcium and magnesium salts, the pH value and the temperature.

If what is known as the lime-carbonic acid balance has been disturbed by an increase in the pH value and/or the temperature, the calcium carbonate precipitates in the form of calcite crystals.

The applicable standards and corresponding technical regulations (e.g. DIN and DVGW) must therefore be observed.

Note:

Request a water analysis from the local utility companies for testing in the event of known regional risks or contested water quality.

Propensity for scaling guidelines as per VDI 2035

Hardness ranges	Millimoles of calcium carbonate/litre	Degree of hardness in °dH	Domestic water temperatures		
			< 60°C	60 - 70°C	> 70 °C
Soft	< 1.5	< 8,4	Low	Low	Low
Medium	1.5 – 2.5	8.4 - 14	Low	Low	Medium
Hard	> 2.5	> 14	Low	Medium	High

7.2 Seized Grundfos pumps, type UPM3

Counter-measures for a seized pump:

Should the pump be seized after a period of disuse and fail to start, the status indicator LED 1 = red and LED 5 = yellow will be displayed. The pump will make repeated autonomous attempts to start electronically with maximum torque for a few seconds.

Especially during / after initial filling of the system, freedom from oxygen (air) in the system must be ensured.

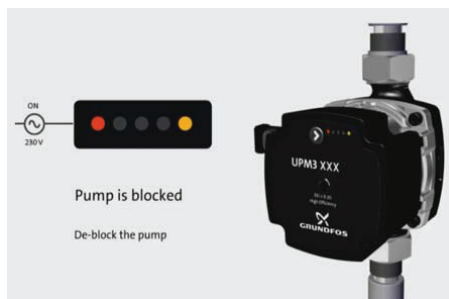
**Notes:**

Downtimes should generally be avoided. (Magnetic) Dirt and air separators must be installed properly in the system so that they work correctly. Freedom from oxygen (air) in the system must be constantly ensured. The medium used must always correspond to VDI 2035.

If the problem persists, the following manual steps can also be taken: In this case, please use the appropriate Phillips screwdriver, e.g. Phillips No.2, and insert it into the front opening in the middle of the pump (see figures). Then press and rotate the piston briefly in both directions with the aid of the screwdriver.

The controller must be permanently connected to the power supply when the system is filled to counteract interference.



The pump should then start and run again (see also the corresponding LED display).

**Note:**

If the pump cannot be restored with this measure, the piston slips through (protection mechanism). It cannot be released and the pump will need to be repaired. -> Directly release the impeller (switch the pump off) or replace it.

The separate documentation from the pump manufacturer must also be taken into account.

8 Design diagrams

8.1 Summary

Diagrams for heating via plate heat exchanger, type B15x40 (item 1a)

Heating secondary side	Primary flow rate required for heating secondary side, depending on the flow line temperature	Return temperature of the primary side in the case of heating on the secondary side, depending on the flow line temperature
by 10K (from 35°C to 45°C)	Diagram 1	Diagram 2
by 7K (from 30°C to 37°C)	Diagram 3	Diagram 4
by 20K (from 45°C to 65°C)	Diagram 5	Diagram 6
by 15K (from 45°C to 60°C)	Diagram 7	Diagram 8

Diagrams for the DHW via plate heat exchanger, type WP24-30 (item 1b*)

Domestic water heating	Primary flow rate required for domestic hot water (DHW) heating, depending on the flow line temperature	Return line temperature on the primary side for domestic hot water (DHW) heating, depending on the flow line temperature
by 35K (from 10°C to 45°C)	Diagram 9	Diagram 10
by 40K (from 10°C to 50°C)	Diagram 11	Diagram 12
by 45K (from 10°C to 55°C)	Diagram 13	Diagram 14
by 50K (from 10°C to 60°C)	Diagram 15	Diagram 16

* Depending on unit variant

Other diagrams for station variants LogoMini G1 1 ... 6 or variant 7:

Flow and pressure loss diagrams

Circuits	Heat interface unit variants	1 to 6	7
Primary	HC	Diagram 17	Diagram 24
	HWH		Diagram 25
Secondary	Tank charging circuit	Diagram 18	
	UC	Diagram 19	Diagram 26
	MC	Diagram 20	
	DHW		Diagram 27

Available differential pressure

Circuit	Heat interface unit variants	1 to 6	7
Secondary	Tank charging circuit	Diagram 21	
	UC	Diagram 22	Diagram 28
	MC (straight)	Diagram 23	

8.2 Primary flow rates and return line temperatures

Diagram 1

LogoMini B15x40: Primary flow rate required for secondary side heating by 10K (from 35°C to 45°C) depending on the flow line temperature (FL-T.)

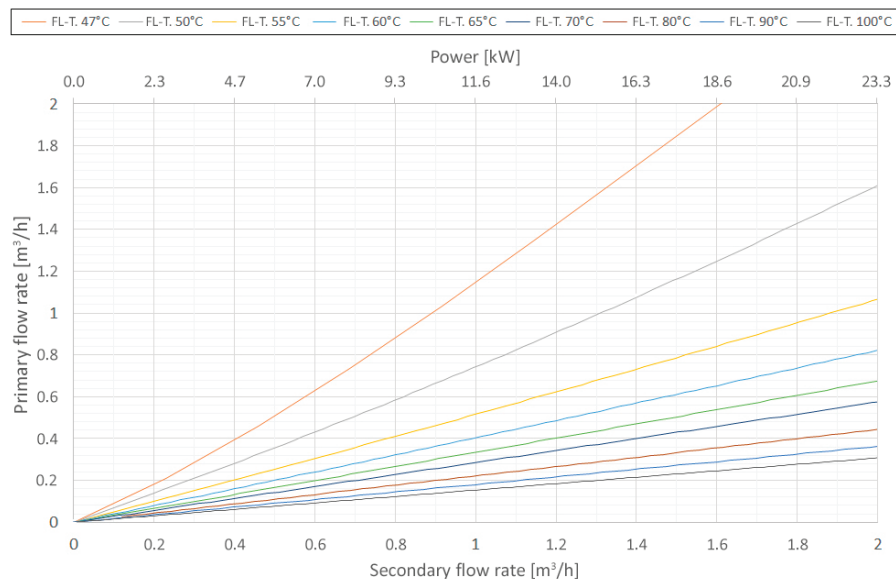

Diagram 2

LogoMini B15x40: Return line temperature on the primary side for secondary side heating by 10K (from 35°C to 45°C) depending on the flow line temperature (FL-T.)

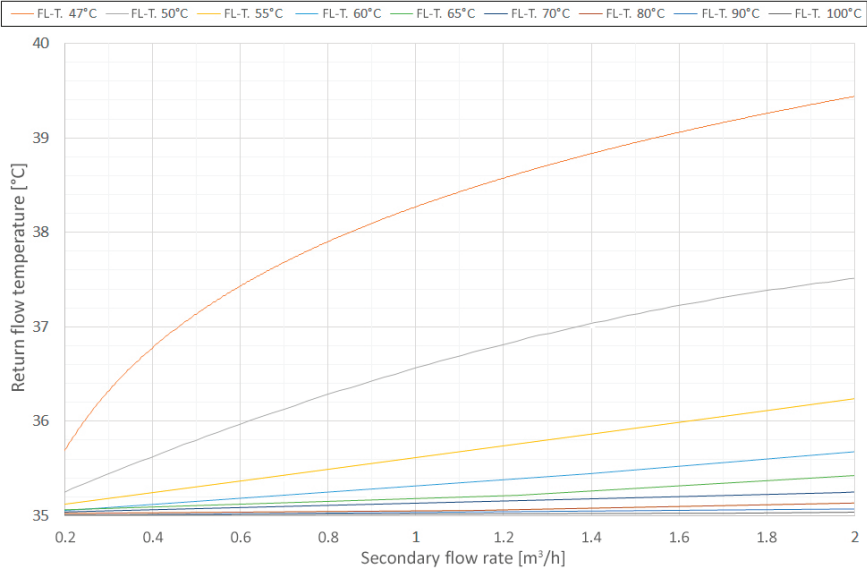

Diagram 3

LogoMini B15x40: Primary flow rate required for secondary side heating by 7K (from 30°C to 37°C) depending on the flow line temperature (FL-T.)

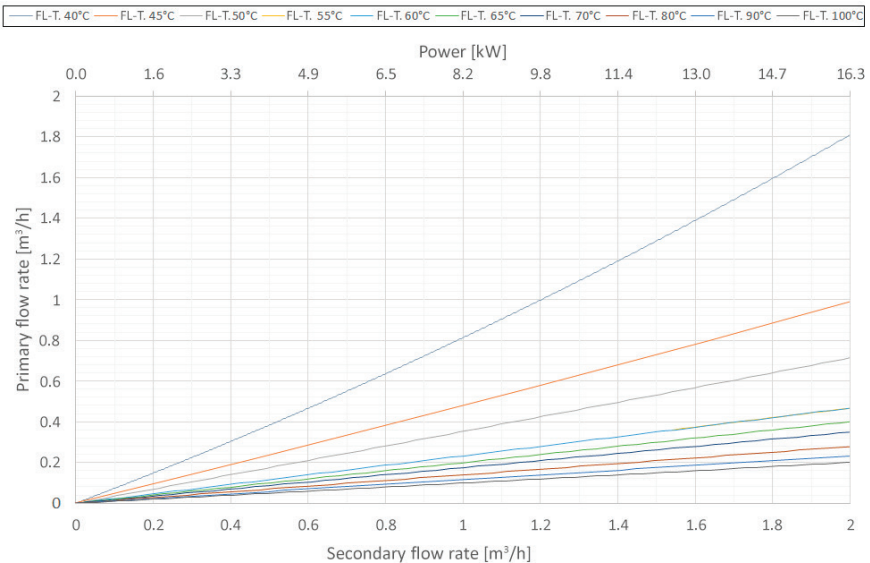

Diagram 4

LogoMini B15x40: Return line temperature on the primary side for secondary side heating by 7K (from 30°C to 37°C) depending on the flow line temperature (FL-T.)

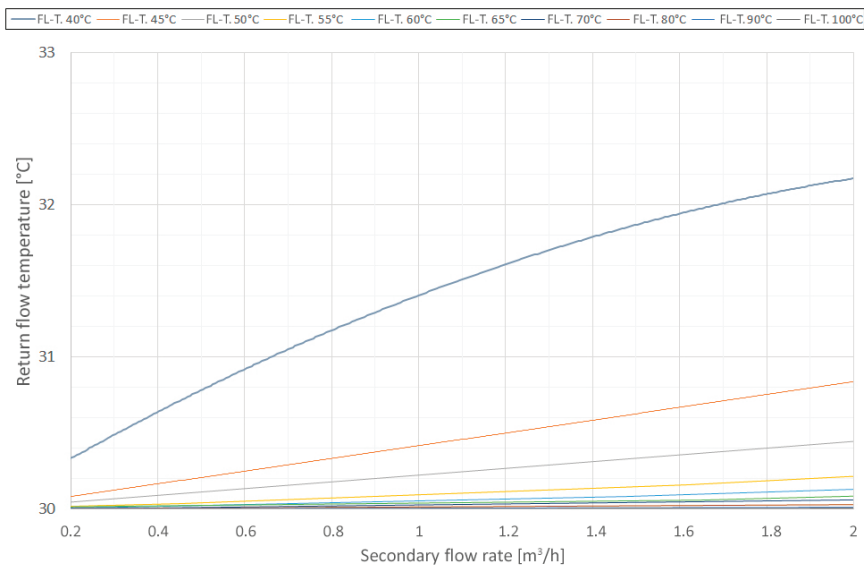

Diagram 5

LogoMini B15x40: Primary flow rate required for secondary side heating by 20K (from 45°C to 65°C) depending on the flow line temperature (FL-T.)

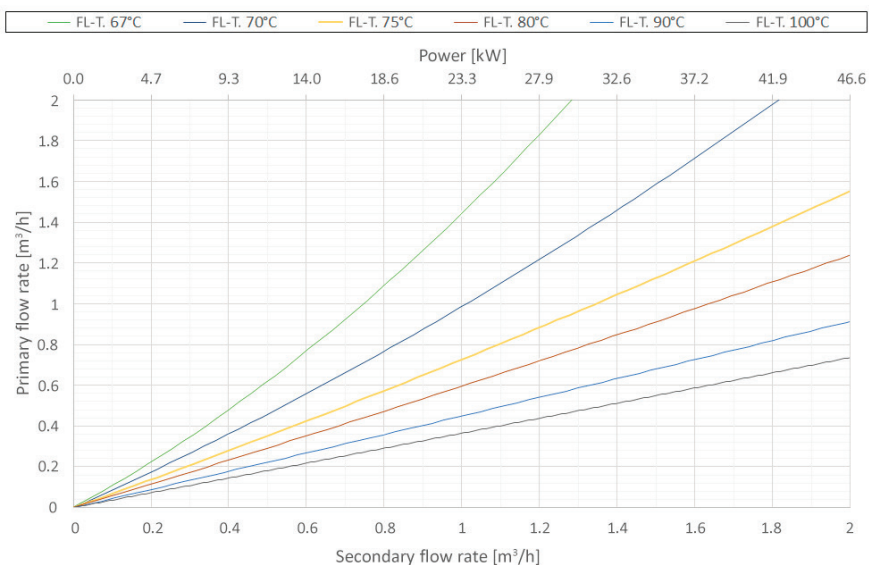

Diagram 6

LogoMini B15x40: Return line temperature on the primary side for secondary side heating by 20K (from 45°C to 65°C) depending on the flow line temperature (FL-T.)

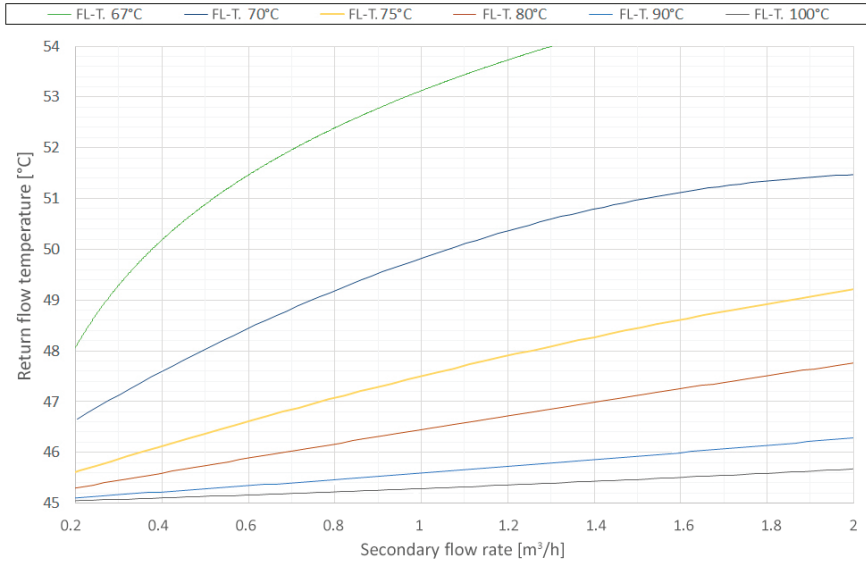

Diagram 7

LogoMini B15x40: Primary flow rate required for secondary side heating by 15K (from 45°C to 60°C) depending on the flow line temperature (FL-T.)

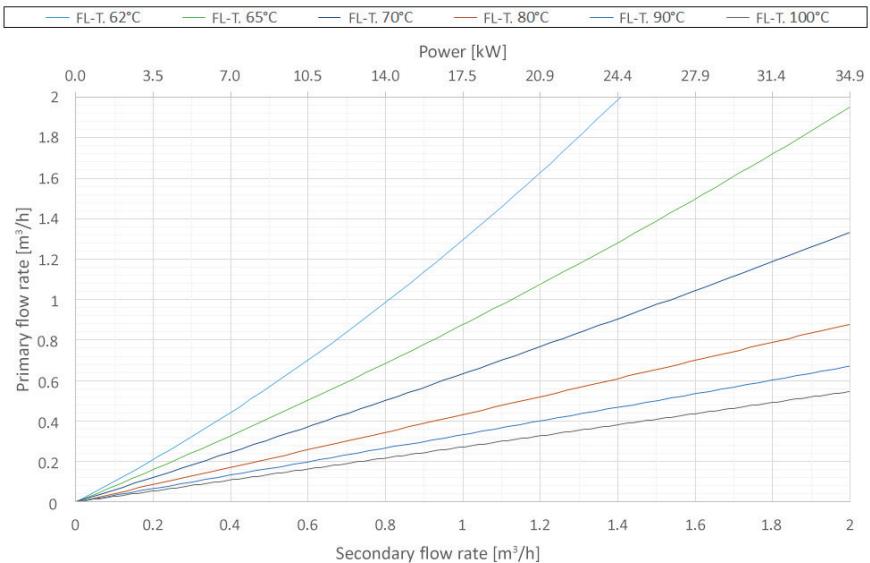

Diagram 8

LogoMini B15x40: Return line temperature on the primary side for secondary side heating by 15K (from 45°C to 60°C) depending on the flow line temperature (FL-T.)

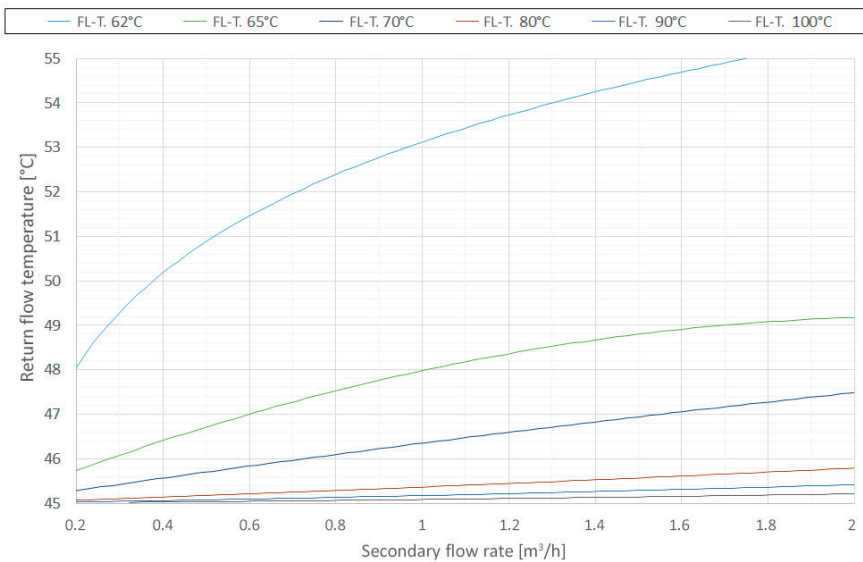

Diagram 9

LogoMini WP24-30: Primary flow rate required for domestic water heating by 35K (from 10°C to 45°C) depending on the flow line temperature (FL-T.)

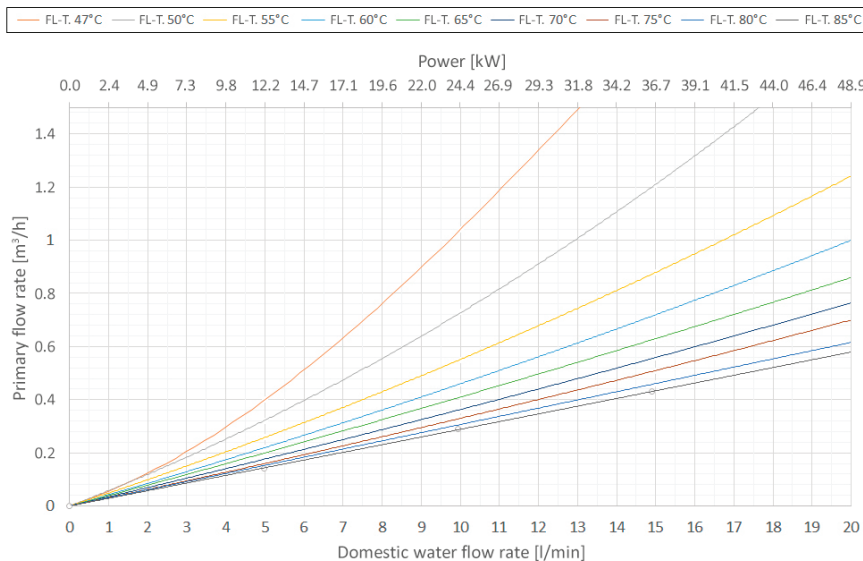

Diagram 10

LogoMini WP24-30: Return line temperature on the primary side for domestic water heating by 35K (from 10°C to 45°C) depending on the flow line temperature (FL-T.)

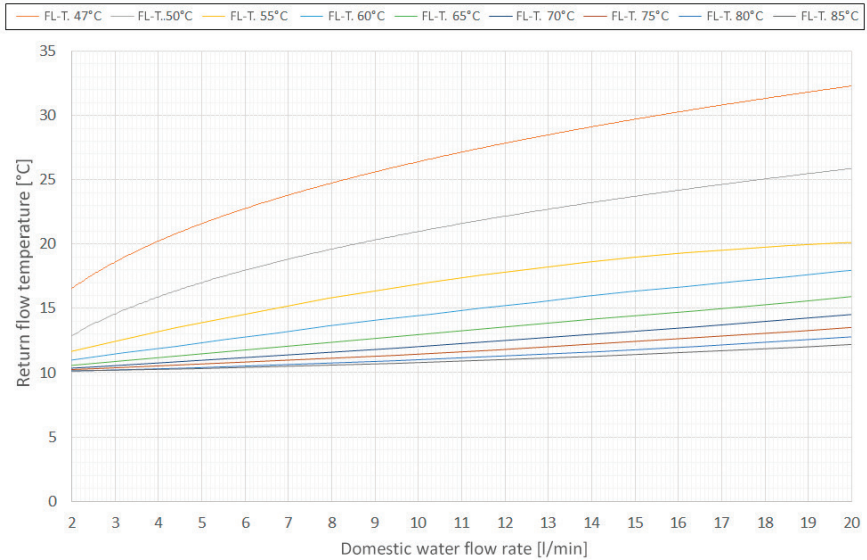

Diagram 11

LogoMini WP24-30: Primary flow rate required for domestic water heating by 40K (from 10°C to 50°C) depending on the flow line temperature (FL-T.)

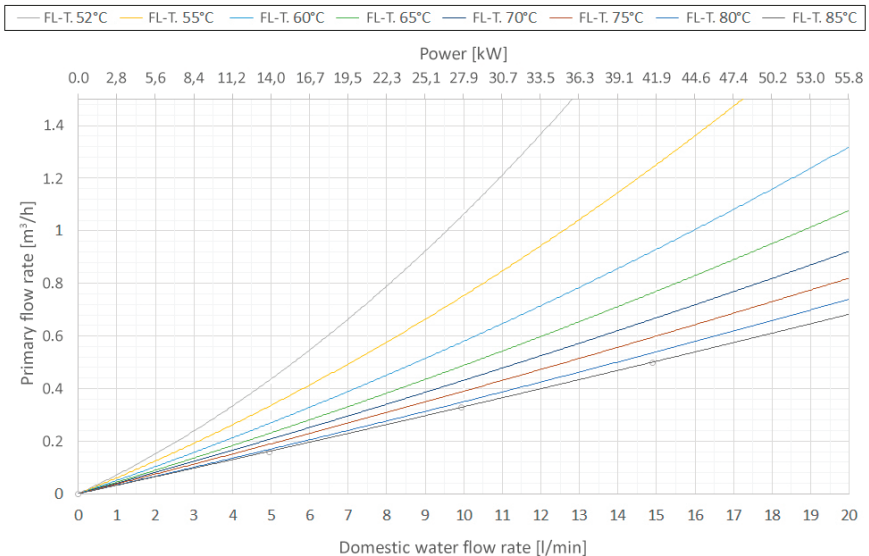

Diagram 12

LogoMini WP24-30: Return line temperature on the primary side for domestic water heating by 40K (from 10°C to 50°C) depending on the flow line temperature (FL-T.)

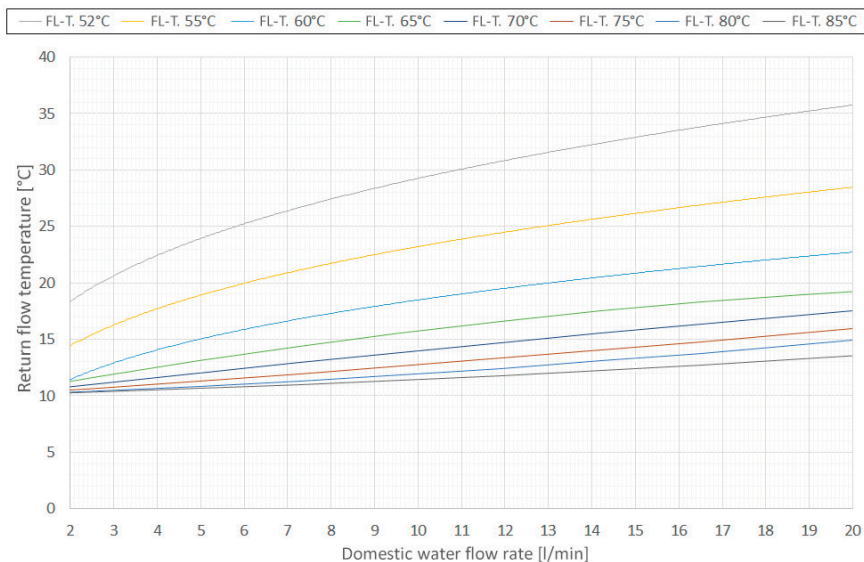

Diagram 13

LogoMini WP24-30: Primary flow rate required for domestic water heating by 45K (from 10°C to 55°C) depending on the flow line temperature (FL-T.)

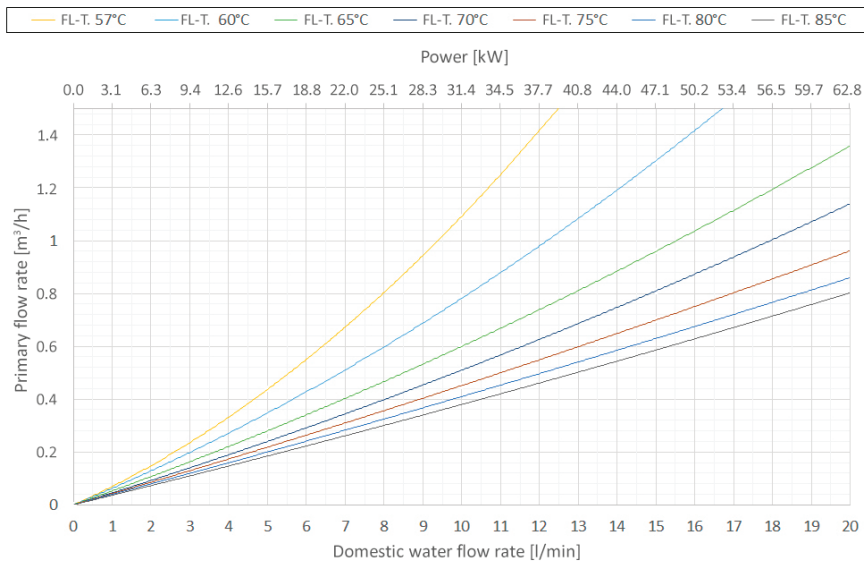

Diagram 14

LogoMini WP24-30: Return line temperature on the primary side for domestic water heating by 45K (from 10°C to 55°C) depending on the flow line temperature (FL-T.)

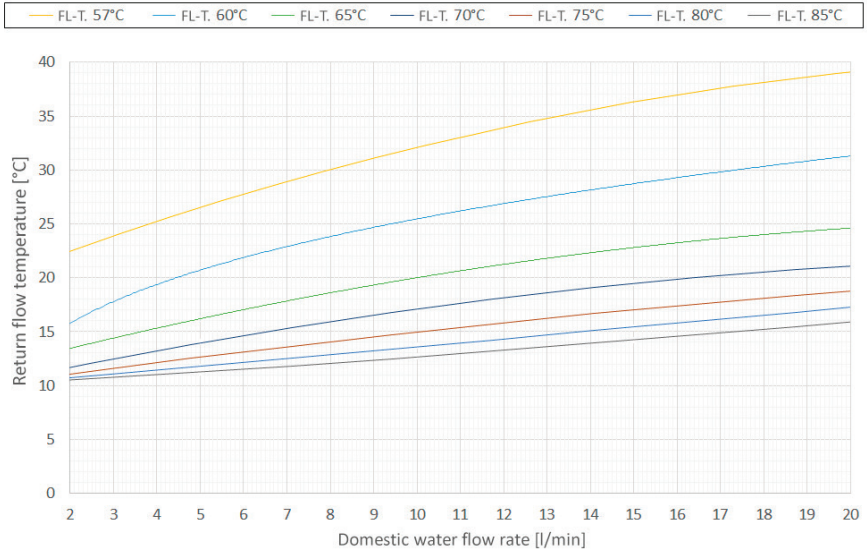

Diagram 15

LogoMini WP24-30: Primary flow rate required for domestic water heating by 50K (from 10°C to 60°C) depending on the flow line temperature (FL-T.)

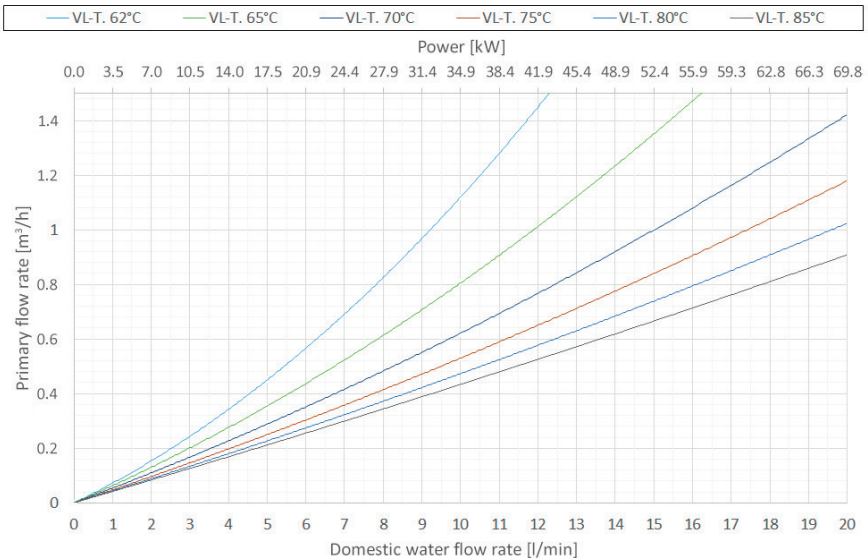
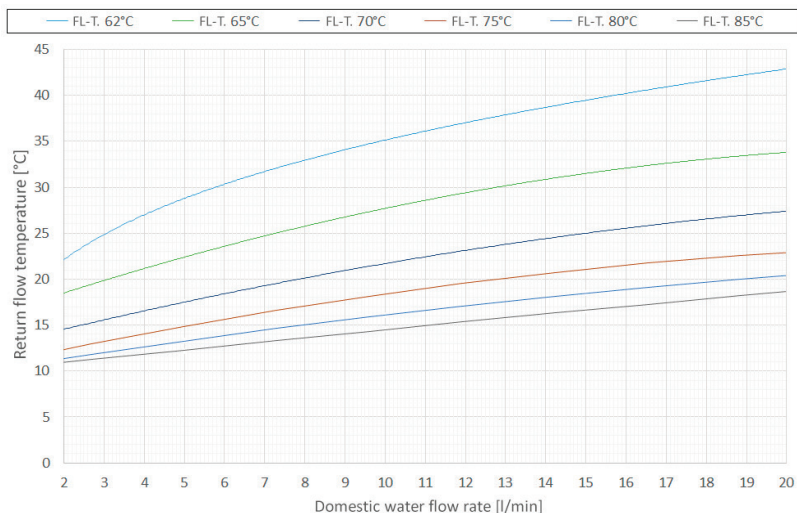

Diagram 16

LogoMini WP24-30: Return line temperature on the primary side for domestic water heating by 50K (from 10°C to 60°C) depending on the flow line temperature (FL-T.)



8.3 Flow and pressure losses and available differential pressure

8.3.1 Diagrams for LogoMini G2 variants 1...6

Diagram 17

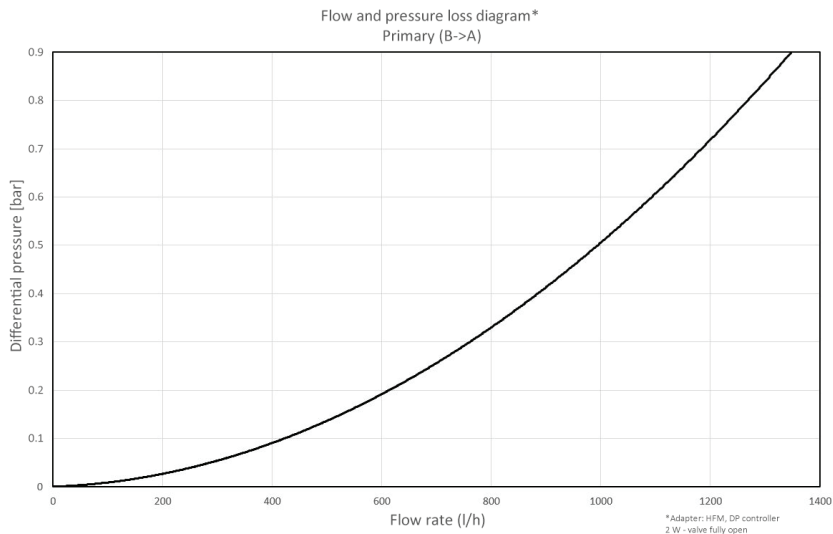

Diagram 18

Flow and pressure loss diagram*

Tank charging circuit (SPL) (D2->C2)

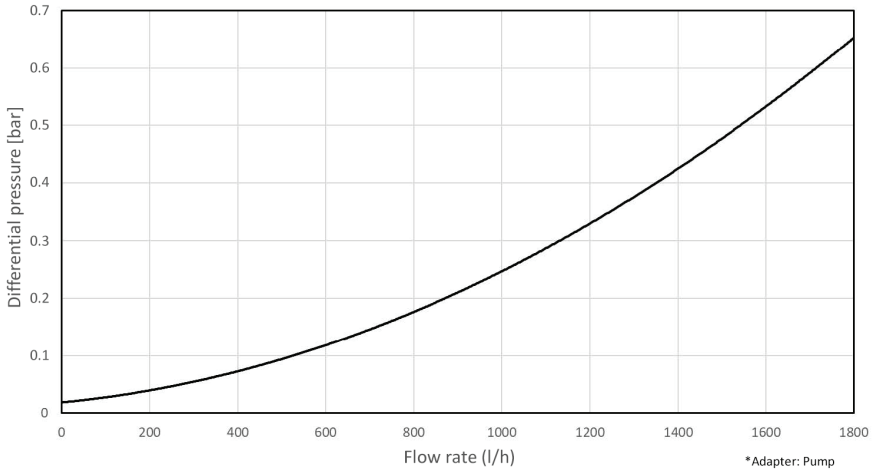

Diagram 19

Flow and pressure loss diagram*

Unmixed circuit (UC) (F->E)

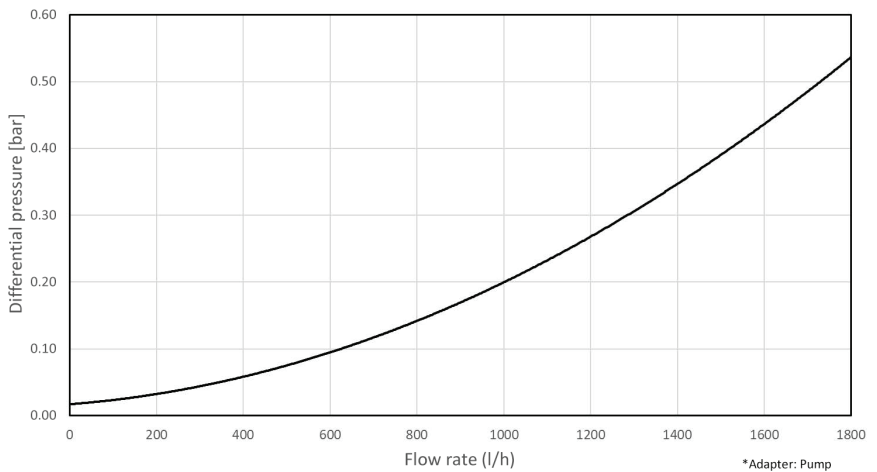

Diagram 20

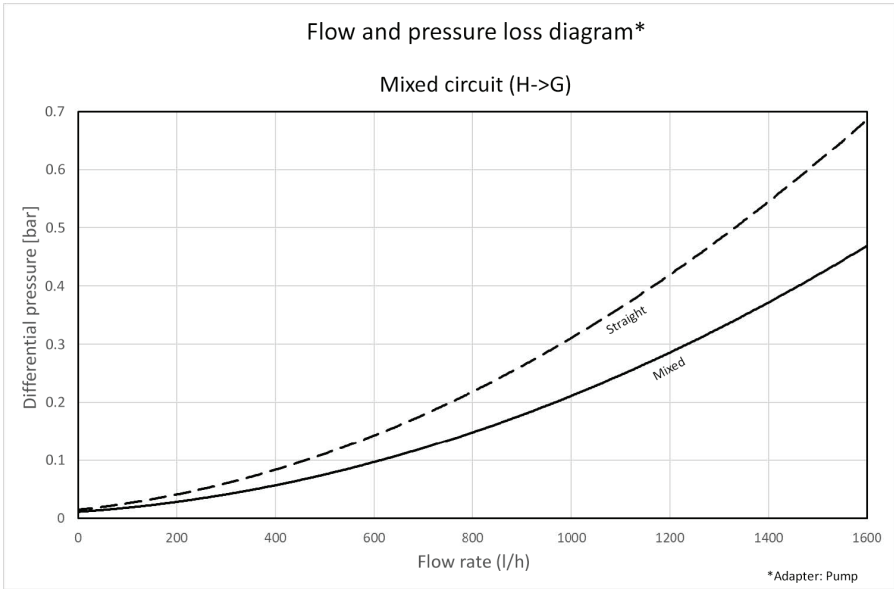

Diagram 21

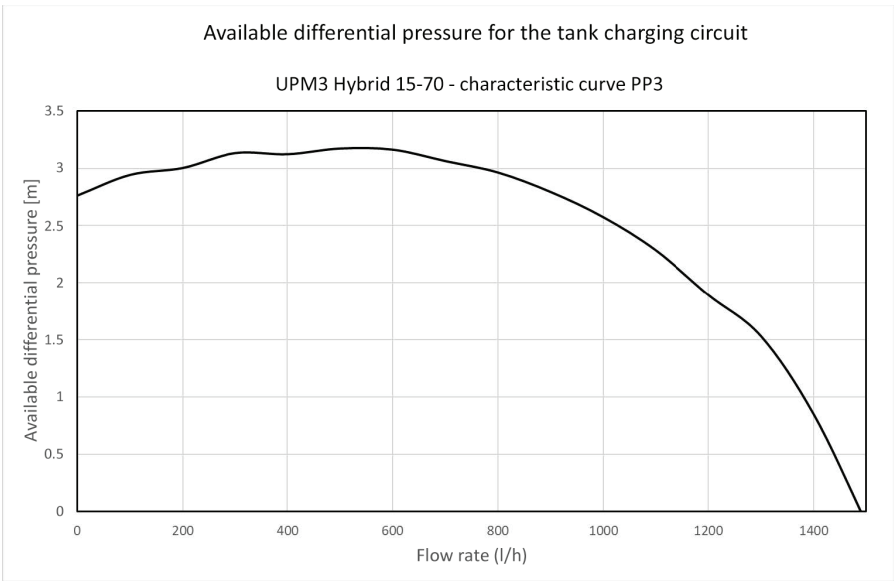

Diagram 22

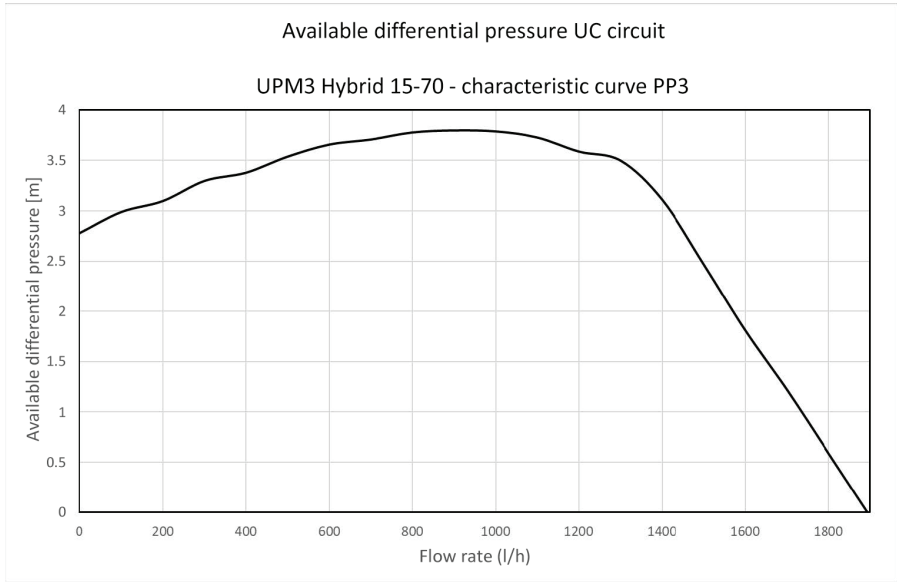
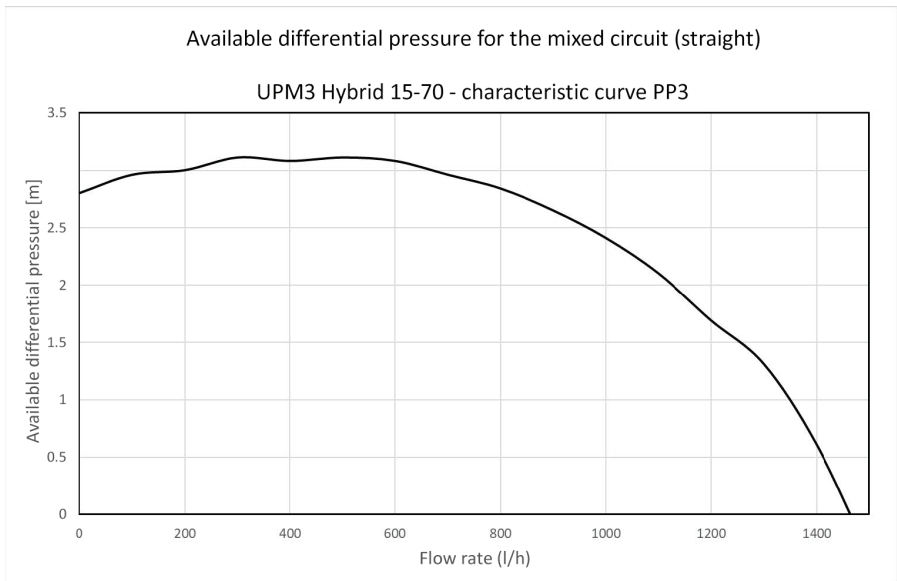

Diagram 23



8.3.2 Diagrams for LogoMini G2 variant 7

Diagram 24

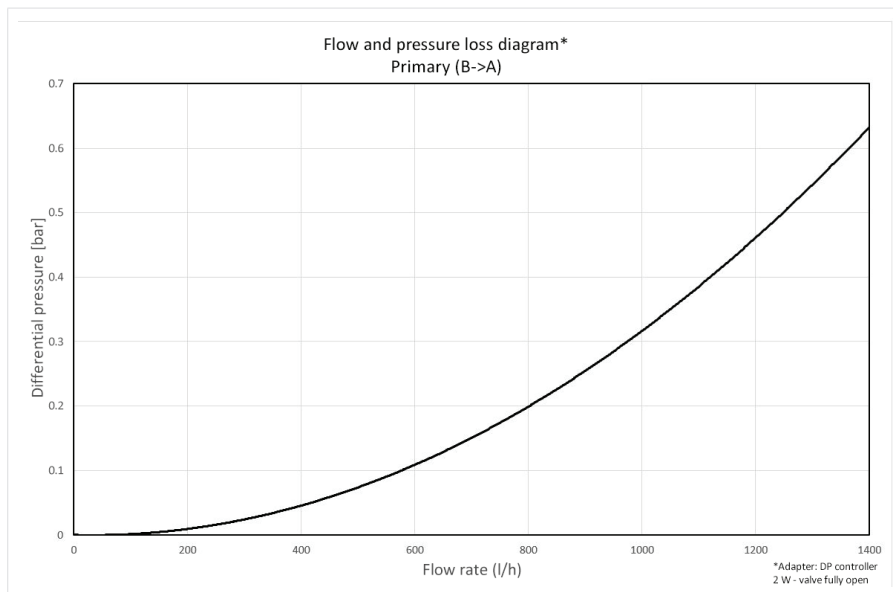

Diagram 25

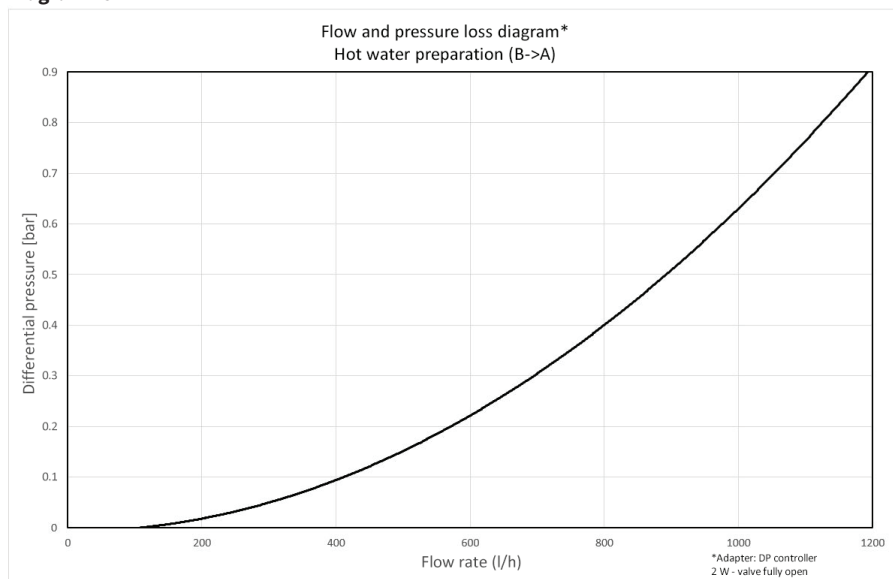

Diagram 26

Diagram 27

Diagram 28

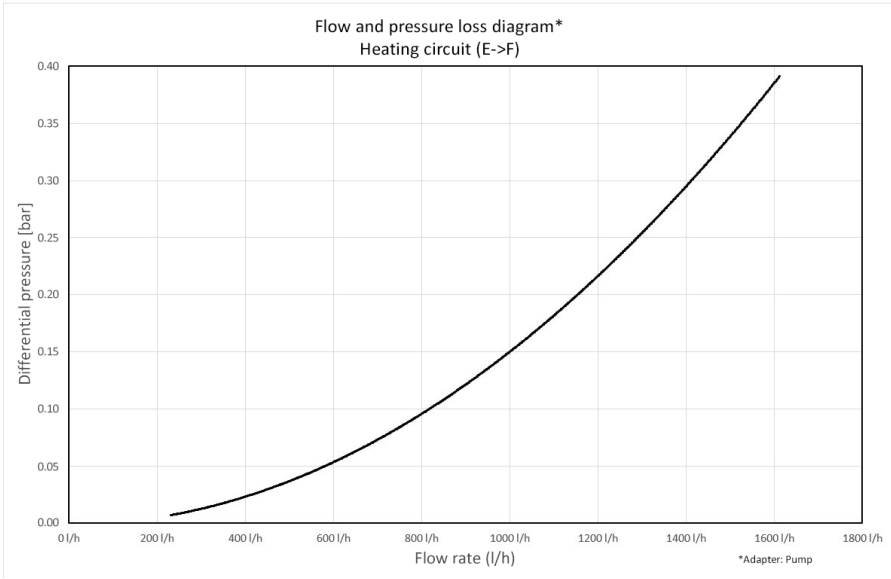
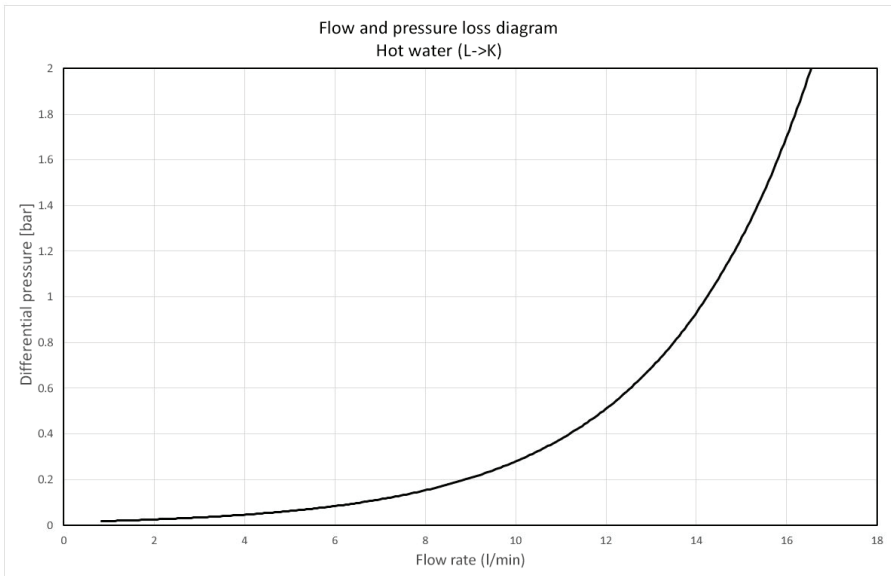
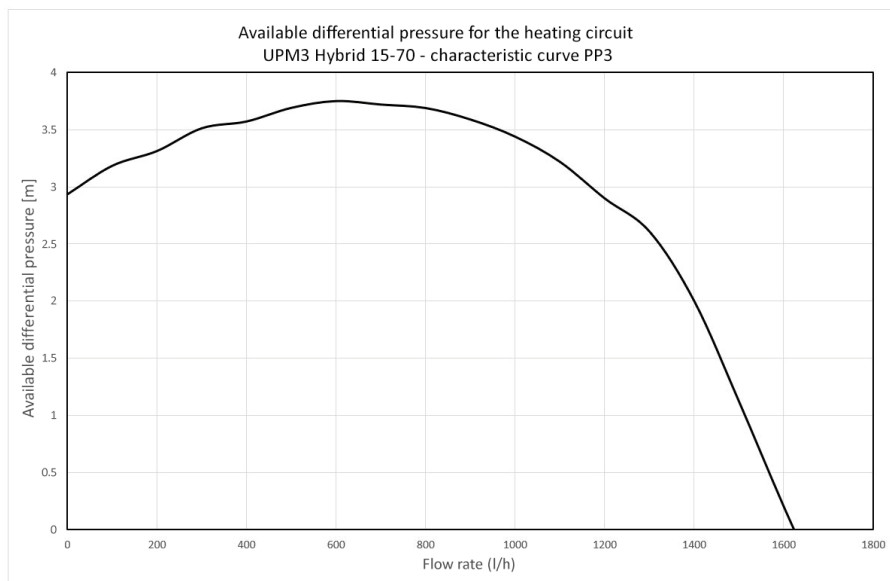

9 Decommissioning, dismantling, disposal, environmental protection and disposal of electrical and electronic equipment

During dismantling, the safety instructions and residual dangers mentioned (see Section 1) must be observed!

Removal and disposal:

Removal and disposal of the device should only be carried out by suitable trained experts. When disposing of the auxiliary and operating materials, always observe the specifications in the safety data sheets, which must be provided by the suppliers of the auxiliary and operating materials. No environmental damage must be caused during disposal. If the device is intended for scrapping, care must be taken to ensure that the individual components are of the correct type when disposing of them. It is necessary to check which way the materials can be recycled properly.

Information according to the Electrical and Electronic Equipment Act (ElektroG)*:

Disposal of electrical and electronic equipment



The "crossed-out wheeled bin" symbol means that you are legally obliged to dispose of these devices separately from unsorted municipal waste. Disposal via household waste, such as the residual waste bin or the yellow bin, is prohibited. Avoid misdirected waste by disposing of it correctly at special collection and return points. As a matter of principle, waste prevention measures take priority over waste management measures. Waste prevention measures for electrical and electronic equipment include, in particular, extending their service life by repairing defective equipment and selling functioning used equipment instead of sending it for disposal.

- Options for returning old equipment

Owners of old devices can return or collect them free of charge within the framework of the possibilities for returning or collecting old devices set up and provided by public waste management authorities. In addition, returns are also possible to distributors under certain conditions.

The distributor must take back the device free of charge when a new device of the same type is purchased (1:1 take-back). There is also the possibility to return old devices to the distributor free of charge if the external dimensions do not exceed 25 centimetres and the return is limited to three old devices per type of device (0:1 take-back).

Retail: Distributors who have a sales area for electrical and electronic equipment of at least 400 square metres are obliged to take back old electronic equipment. Food retailers who have a total sales area of at least 800 square metres and who also offer electrical and electronic equipment several times a calendar year or on a permanent basis and make it available on the market are also obliged to take it back.

Distance selling market: Distributors who sell their products using means of distance communication are obliged to take back old devices if the storage and dispatch areas for electrical and electronic equipment are at least 400 m².

- Removal of batteries and lamps

If the products contain batteries and rechargeable batteries or lamps that can be removed from the old device without destroying it, these must be removed before disposal and disposed of

separately as batteries or lamps.

- Data privacy

We would like to point out to all end users of electrical and electronic equipment that you are responsible for deleting personal data on the electrical and electronic equipment to be disposed of.

**Please observe the country-specific national implementation of the European WEEE Directive 2012/19/EU on waste electrical and electronic equipment that is currently in force.*

Meibes System-Technik GmbH
Ringstrasse 18
D-04827 Gerichshain
Germany
+49 (0) 342 927 130
info@meibes.com
www.flamco.aalberts-hfc.com

Copyright Flamco B.V., Almere, the Netherlands. No part of this publication may be reproduced or published in any way without explicit permission and mention of the source. The data listed are solely applicable to Flamco products. Flamco B.V. shall accept no liability whatsoever for incorrect use, application or interpretation of the technical information. Flamco B.V. reserves the right to make technical alterations.

man_LogoMini G2_24002.956_eng_2023-05